



<https://www.mnsoftball.com>

(763) 390-810-8103

877 Meander Court

Medina, MN 55340

DUDLEY®

Quality, Consistency & Durability

SCAN ME



Order online at <https://www.mnsoftball.com>



Trademarks are owned by Russell Brands, LLC, or its affiliates. ©2013 Russell Brands, LLC



2026 MINNESOTA SOFTBALL STATE TOURNAMENT SCHEDULE

STATE TOURNAMENT	DATES	SITE
8U Girls Fast Pitch	June 27-28	Various Sites
10U Girls Fast Pitch	July 11-12	Various Sites
12U Girls Fast Pitch	July 11-12	Various Sites
14U Girls Fast Pitch	July 25-26	Various Sites
16/18U Girls Fast Pitch	July 25-26	Various Sites
8U Fall Girls Fast Pitch	September 26	Various Sites
10U Fall Girls Fast Pitch	September 26	Various Sites
12U Fall Girls Fast Pitch	September 26	Various Sites
14U Fall Girls Fast Pitch	September 27	Various Sites
16/18U Fall Girls Fast Pitch	September 27	Various Sites

2026 MONSTA CHAMPIONSHIPS

TOURNAMENT	DATES	SITE
9 th Annual Monsta 8U Girls Fast Pitch	July 16-19	Shakopee, MN
9 th Annual Monsta 10U Girls Fast Pitch	July 23-26	Bloomington, MN
9 th Annual Monsta 10U Fast Pitch North	July 30 - August 2	Elk River, MN
9 th Annual Monsta 12U Girls Fast Pitch	July 30 - August 2	Shoreview, MN
9 th Annual Monsta 14U Girls Fast Pitch	August 6 - August 9	Mankato, MN
9 th Annual Monsta 16/18U Girls Fast Pitch	July 31 - August 2	Rochester, MN

For a list of all Minnesota Softball Girls' Fast Pitch Tournaments go to:

<https://mnsoftball.com/pages/cms/minnesota-softball-girls-fast-pitch-tournaments>

For tournaments in states immediately around Minnesota:

- North Dakota - <https://usasoftballnd.com/>
- South Dakota - <https://usasoftballofsouthdakota.com/>
- Wisconsin - <https://usasoftballofwi.com/pages/cms/wisconsin-tournaments>



9TH ANNUAL MONSTA CHAMPIONSHIPS



8-UNDER

All teams will pay the host a \$200 Gate Fee, except 8U which is \$100

Held in **Shakopee, Minnesota** on July 16-19 ● Four Game Guarantee - Two Pool Games into Two Bracket Games ● Awards for the top three teams in all brackets ● Team Parade ● Gift Exchange ● Pin Trading ● 64 teams maximum

\$300

10-UNDER

Added another 10U site to accommodate more teams.

Held in **Bloomington, Minnesota** on July 23-26 ● Five Game Guarantee - Three Pool Games into Two Bracket Games ● Awards for the top three teams in all brackets ● Team Parade ● Gift Exchange ● Pin Trading ● 64 teams maximum

\$550

10-UNDER

Two umpires for all games (pool and bracket)

Held in **Elk River, Minnesota** on July 30-August 2 ● Five Game Guarantee - Three Pool Games into Two Bracket Games ● Awards for the top three teams in all brackets ● Team Parade ● Gift Exchange ● Pin Trading ● 64 teams maximum

\$550

12-UNDER

Platinum, Gold, Silver, and Bronze Brackets

Held in **Shoreview, Minnesota** on July 30-August 2 ● Five Game Guarantee - Three Pool Games into Two Bracket Games ● Awards for the top three teams in all brackets ● Team Parade ● Gift Exchange ● Pin Trading ● 64 teams maximum

\$550

14-UNDER

USA Softball registered and trained officials.

Held in **Mankato, Minnesota** on August 6-9 ● Five Game Guarantee - Three Pool Games into Two Bracket Games ● Awards for the top three teams in all brackets ● Team Parade ● Gift Exchange ● Pin Trading ● 64 teams maximum

\$550

16/18-UNDER

Held in **Rochester, Minnesota** on July 31-August 2 ● Five Game Guarantee - Three Pool Games into Two Bracket Games ● Awards for the top three teams in all brackets ● Team Parade ● Gift Exchange ● Pin Trading ● 64 teams maximum

\$550

MINNESOTA SOFTBALL

2026 USA SOFTBALL GOLD AND A NATIONALS



NATIONAL TOURNAMENT	DATES	SITE
USA Softball 16U GOLD Girls Fast Pitch	July 9 - 12	Oklahoma City, OK
USA Softball 18U GOLD Girls Fast Pitch	July 9 - 12	Oklahoma City, OK
USA Softball 10U A Girls Fast Pitch	July 21 - 26	Johnson City, TN
USA Softball 12U A Girls Fast Pitch	July 21 - 26	Johnson City, TN
USA Softball 14U A Girls Fast Pitch	July 21 - 26	Johnson City, TN
USA Softball 16U A Girls Fast Pitch	July 21 - 26	Johnson City, TN
USA Softball 18U A Girls Fast Pitch	July 21 - 26	Johnson City, TN

2026 USA SOFTBALL GIRLS' NORTHERN CHAMPIONSHIPS

NATIONAL TOURNAMENT	DATES	SITE
USA Softball 10U A Girls Fast Pitch Northern	July 30 – August 2	Sioux Falls, SD
USA Softball 12U A Girls Fast Pitch Northern	July 30 – August 2	Sioux Falls, SD
USA Softball 14U A Girls Fast Pitch Northern	July 30 – August 2	Sioux Falls, SD
USA Softball 16U A Girls Fast Pitch Northern	July 30 – August 2	Sioux Falls, SD
USA Softball 18U A Girls Fast Pitch Northern	July 30 – August 2	Sioux Falls, SD
USA Softball 10U B Girls Fast Pitch Northern	July 30 – August 2	Sioux Falls, SD
USA Softball 12U B Girls Fast Pitch Northern	July 30 – August 2	Sioux Falls, SD
USA Softball 14U B Girls Fast Pitch Northern	July 30 – August 2	Sioux Falls, SD
USA Softball 16U B Girls Fast Pitch Northern	July 30 – August 2	Sioux Falls, SD
USA Softball 18U B Girls Fast Pitch Northern	July 30 – August 2	Sioux Falls, SD

For a list of all USA Softball National Championships go to: <https://www.usasoftball.com/tournaments-national-championships/national-championships/>

For a list of all USA Softball Invitational Tournaments go to: <https://tournamentusasoftball.com/>



MINNESOTA SOFTBALL SELECTS

Sunshine Park

Andover, MN

August 14-16, 2026

Three Game Guarantee • \$90 per player • Player Evaluations

Each Minnesota Softball Select player will get a jersey and a medal.

10U | 12U | 14U | 16U-18U Community Based Players Are Invited!

ENTRY DEADLINE IS JULY 20, 2026 - ABSOLUTELY NO EXCEPTIONS!!!

PLAYER EVALUATIONS

The players along with their team will be evaluated on the following items

- | | | |
|-------------------------------|-------------------|----------------------|
| * Measurable Test and Results | * Strength | * Player Profile |
| * Speed | * Game Report | * Recruitment Locker |
| * Arm | * Scouting Report | |
| * Bat | * Skill Testing | |

MINNESOTA SOFTBALL SELECTS WEEKEND SCHEDULE

- ◆ Friday 5:00PM-6:15PM - Team's check-in, pick up shirts, meet your teammates.
- ◆ Friday 6:30PM - USA Selects Player and Coach Introductions/Parade.
- ◆ Friday 6:35PM - National Anthem.
- ◆ Friday 6:45PM - Welcome and Speeches.
- ◆ Saturday 8:00AM - Games begin.
- ◆ Saturday 9:30AM - FLEXX Sports begins evaluation. Your team will have a pre-scheduled time.
- ◆ Saturday 6:30PM - Last round of games begin.
- ◆ Sunday 8:00AM - Games begin.
- ◆ Sunday 2:00PM - Last round of games begin.

This event is a fun end of the year celebration for the children and coaches that play softball within community based associations. Teams will be divided as equally as we can make them. Your players may NOT end up on the same team. We will need help getting coaches for the weekend too. There will be kids of varying skill levels on all teams.

For more information go to: mnsoftball.com

ABOUT MINNESOTA SOFTBALL

Minnesota Softball is the statewide governing body of amateur softball in Minnesota and an affiliate of USA Softball. Since 1925, Minnesota Softball (formerly known as Minnesota State Diamond Ball Association and Minnesota Amateur Softball Association) has been providing volunteer services for the development and promotion of youth and adult softball in Minnesota.

1935, Minnesota officially joined the Amateur Softball Association (ASA), and Mr. Earnest W. Johnson the Superintendent of Playgrounds for the City of St. Paul was appointed State Commissioner. ASA has since rebranded to USA Softball on January 1, 2017, and is the national governing body of softball in the United States.

Minnesota Softball is the largest softball association in the state registering over 4,000 teams and over 600 umpires annually.

Minnesota Softball hosts over 1,400 teams that participate in its state tournaments annually.

This is our fifteenth year in charge of softball in Minnesota and our ninth under the Minnesota Softball umbrella. Minnesota now registers the third most teams of any state association in the United States. While softball might change and parents are playing less slow pitch, they are getting their daughters more involved in fast pitch. Softball in Minnesota is alive and well!

As the national governing body of softball, it is our responsibility and duty to test the equipment that is used every day in our communities. Manufacturers turn in bats to our testing labs and the bats are either rejected or certified after testing. The same can be said of the softballs.

As our equipment and playing rules have evolved, our partners in the NCAA and the National Federation of High Schools have worked together to create a clear path through Junior Olympic Fast Pitch, High School, and into college. Many other associations outside of the above adopt our rules.

Our latest advancement in softball is our website <https://www.mnsoftball.com>. This change makes being a league director, tournament director, and a coach so much easier. This is by far the most dramatic and positive change we have produced. The website does the following:

- Collects registrations and fees.
- Creates robin schedules for leagues and bracket schedules for tournaments.
- Allow coaches to enter scores for their games so your standings page can be updated quickly.
- Produce team webpages for rosters so your community/tournament can use paperless rosters.
- Team and field conflict warnings, so your schedule is perfect every time.
- Once your schedule is created, umpires can be assigned to games.
- And the website is mobile responsive so you can view the full website and do your work from your phone.

We add new features to our website every week. Get your league more involved with Minnesota Softball and take advantage of running your league or tournament with far less hassle.

Thank you for playing Minnesota Softball!

MINNESOTA SOFTBALL

Phone: (763) 390-8103 or toll free at (833) 450-1814

Address: 877 Meander Court, Medina, MN 55340

Website: <https://www.mnsoftball.com>

Tournament Website: <https://www.mnsoftball.com/>

History Website: <http://www.softballhistorymn.com/>

Facebook Page: <https://www.facebook.com/minnesotasoftball>

Twitter: <https://twitter.com/minnsoftball>

Instagram: <https://www.instagram.com/mnsoftball/>

Do us a favor, give us a like on social media!



MINNESOTA SOFTBALL STATE OFFICE CONTACTS

Commissioner

Dan Pfeffer
(763) 390-8105
dan@mnsoftball.com

Junior Olympic Commissioner

Tom Bye
(763) 390-8103
tbye@josoftball.com

STATE UMPIRE-IN-CHIEF STAFF

State Umpire-In-Chief

Dallas Apfelbacher
(612) 756-1069
dallasapfelbacher@hotmail.com

Fastpitch Umpire-In-Chief

John Schaefer
(636) 328-1638
john.schaefer@live.com

Slow Pitch Umpire-In-Chief

Lon Sorenson
(507) 383-0712
lon_sorenson@hotmail.com

Umpire Website: <https://mnsoftball.com/pages/cms/umpires>

MINNESOTA SOFTBALL DISTRICT STAFF

DISTRICT 1 - Dodge, Fillmore, Freeborn, Goodhue, Houston, Mower, Olmstead, Rice, Steele, Wabasha, Winona counties.		DISTRICT 2 - Blue Earth, Brown, Cottonwood, Faribault, Jackson, Le Sueur, Lincoln, Lyon, Martin, Murray, Nicollet, Nobles, Pipestone, Redwood, Rock, Waseca, Watonwan counties.	
District Commissioner Kevin Dather (651) 380-5761 kddather@gmail.com	District Slow Pitch UIC Eric Stanton (507) 363-2867 thestantons@q.com	District Commissioner Phil Tostenson (507) 382-7337 philtos19@gmail.com	District Slow Pitch UIC Chad Rademaker (507) 469-5743 xmoss88@yahoo.com
District JO Commissioner Open Position	District Fast Pitch UIC Open Position	District JO Commissioner Open Position	District Fast Pitch UIC Open Position

DISTRICT 3 - Anoka, Dakota, Ramsey, Washington counties.		DISTRICT 4 - Hennepin County.	
District Commissioner Donny Robinette (651) 260-5831 silverbackssports@gmail.com	District Slow Pitch UIC Dallas Apfelbacher (612) 756-1069 dallasapfelbacher@hotmail.com	District Commissioner Dan Pfeffer (763) 390-8103 dan@mnssoftball.com	District Slow Pitch UIC Open Position
District JO Commissioner Tom Bye (763) 390-8103 tbye@josoftball.com	District Fast Pitch UIC Dallas Apfelbacher (612) 756-1069 dallasapfelbacher@hotmail.com	District JO Commissioner TBD	District Fast Pitch UIC John Schaefer (636) 328-1638 john.schaefer@live.com

DISTRICT 5 - Carver, Scott, and Wright counties.		DISTRICT 6 - Benton, Big Stone, Chippewa, Kandiyohi, Lac Qui Parle, McLeod, Meeker, Mille Lacs, Morrison, Pope, Renville, Sherburne, Sibley, Stearns, Stevens, Swift, Todd, Traverse, Yellow Medicine counties.	
District Commissioner TBD	District Slow Pitch UIC Gary Kottke (612) 386-0803 gkottke9@gmail.com	District Commissioner Open Position	District Slow Pitch UIC Brad Eisenbeis (701) 541-5268 sportofficial2002@yahoo.com
District JO Commissioner Dan Pfeffer (763) 390-8103 dan@mnssoftball.com	District Fast Pitch UIC Gary Kottke (612) 386-0803 gkottke9@gmail.com	District JO Commissioner Open Position	District Fast Pitch UIC Rich Pohlmeier (320) 583-9738 richpo13@gmail.com

DISTRICT 7 - Aitkin, Carlton, Chisago, Cook, Crow Wing, Isanti, Itasca, Kanabec, Koochiching, Lake, Pine, St. Louis counties.		DISTRICT 8 - Becker, Beltrami, Cass, Clay, Clearwater, Douglas, Grant, Hubbard, Kittson, Lake of the Woods, Mahnommen, Marshall, Norman, Otter Tail, Pennington, Polk, Red Lake, Roseau, Wadena, Wilkin counties.	
District Commissioner Open Position	District Slow Pitch UIC Open Position	District Commissioner Phil Shiek (701) 730-3345 philshiek@gmail.com	District Slow Pitch UIC Position Open
District JO Commissioner Open Position	District Fast Pitch UIC Brian Karich (218) 969-3716 brian@divesportspluswear.com	District JO Commissioner Open Position	District Fast Pitch UIC Charlie Johnson (218) 962-3260 charlie73johnson@gmail.com

Youth **1st** ENVIRONMENT

REMEMBER:

IT'S ABOUT THE KIDS

I WILL:

*KEEP MY COMPETITIVE
ENERGY IN CHECK*

AND ALWAYS:

*TREAT OFFICIALS &
OPPONENTS WITH RESPECT*



Report poor sportsmanship at
youth1stalliance.com



MINNESOTA SOFTBALL ASSIGNOR UMPIRE CONTACT INFORMATION

If you need umpires for your leagues or tournaments, use the information below. Tell the assignor your name, level, time, and date of game and with what association your team is registered.

For more information on umpiring please go to <https://mnsoftball.com/pages/cms/umpires>. Our network of officials will train you and get you games to officiate.

Behind the Mask

Mankato Area
Brian DeVos
softballbriandevos@gmail.com
(507) 398-7807

Hutchinson Umpires

Hutchinson Area
Rich Pohlmeier
richpo13@gmail.com
(320) 583-9378

Midwest Fast Pitch

Eastern Metro Area
Geno Hanson
geno2525@aol.com
(651) 398-8856

Midwest Fast Pitch

Eastern Metro Area
Dan Evans
dmepolitic@yahoo.com
(614) 843-5187

Minnesota Elite

Southwest Metro Area
Mike Kahler
mikekahler92@gmail.com
(952) 913-7713

Minnesota Respected Officials

Southeast Metro Area
Jeremy Shibley
deuce2js@hotmail.com
(612) 978-8306

Rochester Area Umpires

Rochester Area
Kelly Raymond
kraymond66@hotmail.com
(507) 430-3610

Waite Park Officials

St. Cloud Area
Charles Huyink
charleshuyink@yahoo.com

St. Croix Valley Umpires

Western Wisconsin Area
Kindra Witthus
scvumpire@gmail.com
(612) 720-9963

Suburban Umpires

Southern Metro Area
David Quehl
davidquehl@gmail.com
(651) 208-8807

Three Rivers Umpires

Northwest Metro Area
Duane Northagen
dnorthagen@gmail.com
(612) 386-4838

MINNESOTA SOFTBALL LEAGUE CONTACT INFORMATION

Big West League

Western Metro Area
Dan Pfeffer
dan@mnsoftball.com
(763) 390-8105

Crow River League

Central Minnesota Area
Raquel Bushman
crowriverfastpitch@gmail.com
(320) 583-0681

Southeastern Diamonds League

Southeastern Minnesota Area
Mike Burringa
mburinga@lewalt.k12.mn.us
(507) 251-6276

Southeastern Fastpitch Conference

Southeastern Minnesota Area
Ken Nance
nance00@gmail.com
(630) 664-2184

Southern Star League

Southwestern Minnesota Area
Joel Schmidt
southernstarmn@outlook.com
(507) 317-4474

Southern Star League

Southwestern Minnesota Area
Brian DeVos
southernstarmn@outlook.com
(507) 398-7807

Tri County League

Eastern Metro Area
Tom Bye
tbye@josoftball.com
(651) 270-0219

If your league is interested in sanctioning with Minnesota Softball, please contact Dan Pfeffer at dan@mnsoftball.com or (763) 390-8105. It only costs \$25 per team and you get access to our invitationals, state, and national tournaments along with this guidebook.



BIG WEST LEAGUE RULES

- A. All age groups and classes will bat the roster in league games.
- B. League games start at 6:15PM and will be a double header.
- C. The host team will be the home team for the first game. The visiting team will be the home team for the second game of the double header.
- D. League games are 7 innings long or 65 minutes, whichever occurs first. No new inning will start after 65 minutes.
- E. The following run-ahead rule applies:
 - 1. 15 runs after 3 innings.
 - 2. 12 runs after 4 innings.
 - 3. 8 runs after 5 innings.
- F. 10-Under Specific Rules:
 - 1. Teams will be able to score a maximum of 5 runs per half inning.
 - 2. 10-Under Class C – a batter will be out on a third strike independent if the ball was caught or not by the catcher on the pitch. On-base runners may advance at their own risk.
- G. 12-Under B/C Specific Rules:
 - 1. Teams will be able to score a maximum of 5 runs per half inning.
 - 2. If the batter was not out or part of the fifth run of the inning will be the first up to bat the following inning.
- H. If there are questions about any other rules, please refer to the USA Softball Rulebook.

LEAGUE TOURNAMENT RULES

- A. All Tournaments will be conducted as double elimination tournaments.
- B. Umpires and game balls will be furnished by the Big West Fastpitch League.
- I. Tournament games are seven (7) innings long or 65 minutes, whichever occurs first. No new inning will start after 65 minutes.
- C. The tie-breaker rule shall be used after seven (7) innings or in the top of the first new inning after time limit expires.
 - 1. Tie Breaker Rule: The offensive team shall begin its turn at bat with the player who is scheduled to bat last in that respective half inning being placed on second base (e.g., if the number five batter is the leadoff batter, the number four batter in the batting order will be placed on second base. A substitute may be inserted for the runner). Games shall be played until a winner is decided on the field of play.
- D. In the event of delays due to inclement weather or extenuating circumstances:
 - 1. The tournament director is empowered to shorten game times to no less than 45 minutes.
 - 2. Games may be suspended after 3 complete innings or 2 1/2 innings if the home team is ahead, which are not tied, may be declared complete games by the tournament director.
 - 3. Every effort must be made to complete the tournament. However, if playing conditions are untenable, the tournament director is empowered to cancel the tournament.
- E. 10-Under Specific Rules:
 - 1. Teams will be able to score a maximum of 5 runs per half inning.
 - 2. 10-Under Class C – a batter will be out on a third strike independent if the ball was caught or not by the catcher on the pitch. On-base runners may advance at their own risk.
- F. If there are questions about any other rules, please refer to the USA Softball Rulebook.



SOUTHERN STAR LEAGUE RULES AND REGULATIONS

<https://southernstarsoftball.org/>

- All games are played under USA rules except for the in-house rules listed below.
- Dropped 3rd strike / base stealing
 - 10U League
 - Drop third strike, batter is out and on base runners may advance only one base
 - Stealing is allowed to all bases, but no advancing on an overthrow/bad throw. Only the base you are stealing.
 - 12's, 14's, 16's & 18's follow USA rules.
 - Dropped third strike with nobody on first base or 2 outs, batter must be tagged or thrown out at first.
 - Stealing of all bases allowed.
 - No limit to the number of bases allowed to advance on overthrows.
- Game(s) – teams can play doubleheaders or just a single game.
- Start time is 6pm and 7:15pm (times can be changed if both teams agree)
- Game Time Limits:
- 10u - 60 min. If tied NO international inning report as tied. Next game starts 5/10 minutes after completion of game one.
- 12u - 65 min. If tied, play 1 international inning to try breaking the tie. Next game starts 5/10 minutes after the completion of game one.
- 14u/16u/18u - 65 min. IF tied 1 international inning. Next game starts 5/10 min. After completion of 1st, coaches/umpires decide.
- Teams may play one 7 inning game if agreed to by BOTH coaches. Time limit is 10U – 120 minutes, 12U – 130 minutes, 14U/16U/18U – 130 minutes. Run rules STAY in effect for this game.
- Tie Breaker Rule - if tied at time limit you play 1 more inning, if still tied it goes in the book as a tie. You can wait to play the tie out at the end of the 2nd game if both teams choose.
- If both teams' coaches agree you can start the game anytime with some schools still going you might want to play earlier. You can also play the game any day of the week that works for both teams.
- Make sure you play all your games as some towns only play 1 night a week, so they don't have as many games to play.
- Please remember to enter the outcome of the game on the league website, if only playing one game just enter a 0 – 0 tie for 2nd game.
- Tied Games – 1 inning of international tiebreaker format. If still tied after that inning, the game is a tie.
- Free Substitution / Continuous batting
 - 10's, 12's, & 14's are required to play/bat all players
 - 16's / 18's is the coach's choice and declared at the start of the game. Both teams are not required to play the same way.
 - Courtesy runners for Pitcher & Catcher are the last out on the line up.
 - 16's & 18's not playing Free Substitution must follow USA rules for courtesy runners.

- If a player is injured and cannot continue to play, that spot is skipped in the batting order and not declared an out.
- Only 9 players on defense.
- Five Run Rule (10's, 12's & 14's only) a maximum of 5 runs may be scored per half inning.
- Run ahead rule - 10's, 12's, 14's, 16's & 18's: 15 runs after 3 innings, 12 runs after 4 innings, 8 runs after five innings. Run rules cannot be waived.
- All pitchers and corner infielders are required to wear a defensive mask, no waivers will be allowed. If face masks are not worn the games will be declared a forfeit by the offending team.
- Helmets with face masks are mandatory.
 - Chin straps are not required,
 - If used, they must be tightened properly
- Teams are allowed to start and/or finish a game with eight players without penalty, unless the 9th player is disqualified. The 9th position in the batting order is not declared an out. A catcher must be used in the defensive line up.
- Metal cleats are allowed in 14's & 16's / 18's
- Pitching Distance
 - 10's – 35 ft
 - 12's – 40 ft
 - 14's & 16's & 18's – 43 ft
- Bases are 60'
- Home Team provides 1 new ball & 1 good used ball for the game.

2026 SOUTHERN STAR LEAGUE 8-UNDER RULES

- Teams will bat the roster
- 3 runs/inning or 3 outs, whichever occurs first
- No Stealing, use this time to teach the correct way to lead off the bases.
- Bunting is not allowed
- Infield Fly Rule will not be applied
- Adults may be on the field but not interfering with play, directions only.
- Coach pitched, but the player plays defense as the pitcher.
- You may place an adult behind the catcher to speed up the passed ball situation, no assisting on live ball and tag outs at home plate.
- Each batter gets 5 hittable pitches per at bat, it will be considered a strike out at this point. If the last pitch was a foul ball, the at bat will continue just as with all other age groups. No walking.
- Dropped third strike is an out.
- Defense will play with 9 players on the field, there will be no penalty for playing with 8 players.
- No new inning after 60 minutes
- Score does not need to be kept; this is for learning only don't need winners/losers
- No umpire needed, coaches get together and get the rules right.
- Softie Softballs will be used for all games

TRI COUNTY RULES

1. 6:00PM Doubleheaders. Games are 7 innings or 65 minutes in length.
2. The host team is responsible for providing USA registered umpires.
3. All games must be a minimum of 3 innings, 2 ½ if the home team is ahead. 1 or 2 inning games will not count toward seeding. If a game is called for any reason, please resolve on the field with umpire if necessary.
4. The home team is considered the local team for the first game / second game is the traveling team. Each team is required to provide one new and one used game ball per doubleheader.
5. The host team coach/manager is responsible for entering their scores to the Tri County web site within 24 hours of completing the game.
6. Tie Breaker Rule: The offensive team shall begin its turn at bat with the player who is scheduled to bat last in that respective half inning being placed on second base (e.g., if the number five batter is the leadoff batter, the number four batter in the batting order will be placed on second base. A substitute may be inserted for the runner).
7. League games can end with a tie. These are doubleheader games, and it is the responsibility of the umpire to keep the games going to complete both games.
8. 15 runs after 3 innings, 12 runs after 4 and 8 runs after 5 innings.
9. Teams are required to make up games before the on-line seed meeting.
10. On deck batters' will be placed to the back of the batter for safety purposes.
11. Steel cleats to be allowed at 14U.
12. Jewelry, see USA Softball rule book, Rule 3, Section 6, Article F, page 40 for exceptions.
13. Make as an option, 5 run rule at 12U C, if proposed before the game and mutually agreed upon by the coaches. This will be for league play only.
14. Three coaches/adults will be allowed on the bench. At least one coach must be ACE educated. All bench coaches/adults must have a background check and be SafeSport trained.

Batting

1. In League play all teams bat the roster.
2. For League Tournament and State Tournament All 10U & 12U (except at Tier 1 State) 14U, 16U, and 18U at B and C levels bat the roster.
3. For League Tournament and State Tournament, 12U Tier 1, 14U 16U & 18U at (A) level bat 9 (DP/Flex). If an age group is combined with an A teams', then bat 9 (DP/Flex).

10U Specific

1. 10U A&B follow the same rules as the older age groups with the following exceptions:
2. 10U C will follow the dropped 3rd strike rule. Batter will be out on a dropped 3rd strike. On-base runners may advance at their own risk.
3. Teams are limited to 5 runs per half inning. The last batter to bat, if they were not out or were not a part of the 5th run, i.e. got a hit or walked then they will be first up to bat the following inning.
4. Use an 11" ball.
5. All 10U will play one doubleheader, 65-minute games on Thursday night until school is out. Tuesday and Thursday night doubleheaders will begin after the school year has ended.

Pitching Distance

- 10U 35'
- 12U 40'
- 14U 43'

No Shows: A team must contact their opponent by 4:00 PM on game day if they are not able to play. Failure to do so results in a "Forfeit due to no show." This will be recorded as a 7-0 win. Any team forfeiting three league night games will be ineligible to play in the league qualifier tournament.

MINNESOTA SOFTBALL 8-UNDER STATE TOURNAMENT FAST PITCH RULES

(complete set of playing rules are found at <https://mnsoftball.com/pages/cms/metro-area-8-under-league>)

GAME PLAY

- Coaches need to operate the game with the highest amount of integrity. At all times keep the kid's best interest in mind.
- Games will be five (5) innings or 65-minute time limit. Home team must be ahead after 2 ½ innings to be considered complete. Please hustle on and off the field to keep the games moving along.
- Games cannot end in a tie. 8U will use the tie breaker rule and start the inning with a runner on second base with two (2) outs. The last out will be the runner placed at second base. If the tie is not broken after the inning, the game will continue for a maximum of three innings. If game is still tied after three innings, a coin flip will determine the winner.
- Teams will bat all players in attendance on their roster.
- Half innings are complete after three (3) outs or five (5) runs.
- Run ahead rule: fifteen (15) after three (3) innings, twelve (12) after four (4) innings, and eight (8) after five (5) innings.
- There may be youth umpires for the State Tournament games. Calls will not be disputed. If there is a concern, talk to the tournament director.
- The home team will be determined by a coin toss.
- After the game, the umpire will turn in the blue card with the final score.
- Defense will have nine (9) players on the field. However, there will be no penalty for playing with eight (8) players. Teams with seven (7) players can play, however, the eighth player in the line-up will be out.
- Each batter gets three (3) swings or five (5) pitches unless the last pitch is a foul ball. The at bat will continue on a foul ball just as with all other age groups. An errant pitch because of machine error will not count against pitch count.
- Bunting is not allowed.
- The infield fly rule will not be applied.
- Runners will not be allowed to advance after a dropped third strike.
- Stealing is not allowed.
- Designated players (DP) will not be allowed.
- Leading off is not allowed. Runners may not leave their base until the ball contacts the bat.
- The pitcher must stay in the pitcher's circle and behind or on the side of the coach until the ball contacts the bat. For clarification, draw a line at the 35' mark across the entire circle and use that line for the pitcher to stand behind. The pitcher may line up on either side of the pitching machine. However, absolutely no movement can be made by the pitcher who places them in front of the pitching machine and or coach prior to pitch.
- Prior to the pitch, the pitching coach must check with the defensive coach that their players are in position and ready for play to begin. The pitching coach can simply raise their 'nonpitching' hand to start the process. Arm up, middle, down, release the machine arm.
- Outfielders must start the play standing on the grass at the edge of the infield or deeper. If the infield is cut for baseball create an arc 15 feet behind the bases and the outfielders must start behind that. They cannot move until the bat has contacted the ball.

Players and runners will stop when:

- A ball that never leaves the infield: If no fielder has control of the ball the runners may continue to advance at their own risk regardless of starting on/off the base. However, once a fielder has control of the ball the runners should stop at the next base. This encourages the infielder to throw the ball to the appropriate base without the fear of runners advancing to the next base because of an overthrow. (Example; A batter hits a ground ball; the infielder fields the ball and makes a throw towards first base. The runner must stop at first base and may not advance to second base. If the ball is caught or the runner is tagged out at first base prior to the runner reaching first base the runner is out.)
- Ball fielded on the dirt, or the arc equals one (1) base per infield hit.

- A ball hit to the outfield: If no outfielder has control of the ball the runners may continue to advance. Once the outfielder gains control of the ball and throws (releases) it toward the infield the runners will stop at the next base, even if the ball doesn't make it to the "dirt" on the throw. Exception, the outfielder can carry the ball to the infield to make an out. The runners can keep advancing in this situation.
- Maximum number of coaches allowed on the field: The defense can have three (3) coaches. Two (2) coaches will be in the field, and one (1) will be working with catcher on technique and proper fitting of catcher's gear. The offense can have three coaches (3). Two will be base coaches and one will be running the pitching machine.
- Coaches are part of the field and are in play and need to make every effort to stay out of the players' way.
- The coach feeding the pitching machine must keep a maximum of two (2) softballs in his/her possession and not lay on the ground around the machine.

METRO AREA HIGH SCHOOL (16U/18U) LEAGUE RULES

Big West and Tri County 16-Under and 18-Under teams will play in a combined league.

Games will be played on Monday and Wednesday. You are required to only play league one night if you want to. Your team is required to play five (5) nights for a minimum of ten (10) league games.

Teams have the option to bat as many players as they want in league games, use 9 players, or 9 DP/FLEX.

If a coach is batting more than nine (9) players, they may reduce their lineup with no penalty. Once a lineup is reduced below nine (9) players, an out will occur in the missing player's spot.

This league, state qualifier, and state will have teams from different age groups and classes. Teams will be seeded and placed in a state tournament based on ranking, not age or classification.

The pitching distance is 43 feet. The base distance is 60 feet. Metal cleats are allowed.

The first game will start at 6:15PM and the second game will start five (5) minutes after the first game has ended.

The host team will be the home team in the first game. The visiting team will be the home team in the second game.

Games are 65 minutes, 7 innings long, or shortened by run rule. The run rule is 15 runs after 3 innings, 12 runs after 4 innings, and 8 runs after 5 innings.

INVITATIONAL TOURNAMENT REGISTRATION

Minnesota Softball is switching our tournament operation to <https://www.mnsoftball.com>. You can find all the registered youth tournaments on this site.

All teams that register to play in Minnesota Softball tournaments must be sanctioned. If your team plays in one of our sanctioned leagues, there is no fee. All other teams must pay \$50 to get sanctioned.

Here are the tournament management features that come with the website.

- Online tournament registrations with email notification for every team registered
- Accept different types of tournament registration fees
 - Credit Cards
 - Venmo
 - Zelle
 - PayPal
 - Checks
 - Cash
 - CashApp
- Track payments
- Seed teams based on prior tournament results
- Schedule the tournament
 - Pool Play
 - Brackets
 - Two-click process to advance teams to the brackets from the pools
- You can give tournament staff permission
 - Score entry
 - Financial management
 - Umpire assignment
- Contact the team managers and players through your communication module
 - Rainout information
 - Schedule changes
- Live brackets with live scoring
 - Allow coaches to enter scores on your live brackets
- Final standings and hand out national tournament berths
- Assign umpires or export a schedule for your assignor
- Generate an umpire schedule
- **Paperless/Online rosters**

There are so many features that will make getting teams to play and pay that your tournament operation life will be a ton easier.

The system will cost \$10 per team to use. All you must do is increase your tournament registration fee by \$10 and you are using the system and insuring your tournament.

If you have questions about the website, please contact Dan Pfeffer at dan@mnsoftball.com or (763) 390-8105.

2026 MINNESOTA SOFTBALL YOUTH SOFTBALL TOURNAMENTS

To get the latest tournament list go to: <https://mnsoftball.com/pages/cms/minnesota-softball-girls-fast-pitch-tournaments>. Entry fees for 8U tournaments are most likely lower than advertised below.

DATE	TOURNAMENT	CITY	AGE	CLASS	ENTRY	EMAIL
May 1-3	OMGAA Battle on the Turf	Maple Grove	10U	A, B, C	\$425	thetricouple@gmail.com
May 1-3	7th Annual Shake the Lake	Prior Lake	10U, 12U	A, B	\$425	stevetarahawks@gmail.com
May 2	Scrimmage Fest	Belle Plaine	8U	A, B, C	\$125	bpfa.tigers@gmail.com
May 2	Rebels Classic	Champlin	8U	A, B, C	\$250	dan@thepowershometeam.com
May 2-3	Mounds View One Day Madness	Shoreview	10U	A, B, C	\$350	dan.pritchard@comcast.net
May 3	Season Opener	Belle Plaine	10U	B, C	\$400	bpfa.tigers@gmail.com
May 8-10	Burnsville Fireball	Savage	8U, 10U, 12U	A, B, C	\$175-\$400	burnsvillefastpitch@gmail.com
May 8-10	10th Annual Swing into Spring	Elk River	10U, 12U	A, B, C	\$500	gabriel.fransen@gmail.com
May 9	Panther Classic	Coon Rapids	8U, 10U, 12U	A, B, C	\$175-\$375	dan.berendes@target.com
May 9	Tonka One Day	Minnetonka	10U	B, C	\$350	jessesteinwand@gmail.com
May 9-10	33rd Annual MayFly	Edina	10U, 12U	A, B	\$450	njohnson115@live.com
May 9-10	Rising Stars	St. Peter	10U, 12U	A, B, C	\$495	kjhmah@yahoo.com
May 9-10	Lakeville Classic	Lakeville	10U, 12U	A, B, C	\$500	nicole@lakevillefastpitch.org
May 10	Tonka One Day	Minnetonka	12U	B, C	\$350	jessesteinwand@gmail.com
May 10	Mounds View 10C Mother's Day	Shoreview	10U	C	\$350	dan.pritchard@comcast.net
May 15-17	OMGAA Battle on the Turf	Maple Grove	12U	A, B, C	\$425	thetricouple@gmail.com
May 15-17	18th Annual Rally in the Valley	Apple Valley	8U, 10U, 12U	A, B, C	\$200-\$500	jdbullock@gmail.com
May 15-17	Centennial Lakes Classic	Circle Pines	10U	B, C	\$425	clittleleague@comcast.net
May 15-17	River Rumble	Mendota Heights	10U, 12U	B, C	\$425	tbstevens@gmail.com
May 15-17	Anoka-Ramsey Dirt Devil	Ramsey	8U, 10U, 12U	B, C	\$375-\$475	matthewmilton@msn.com
May 15-17	Oriole Opener	St. Louis Park	8U, 10U, 12U	B, C	\$250-\$450	david.ritter06@gmail.com
May 15-17	Woodbury Wild Pitch	Woodbury	8U, 10U, 12U	A, B, C	\$250-\$450	sbtravel@waawoodbury.org
May 15-17	Wildcat Walk-Off	River Falls	8U, 10U, 12U	A, B, C	\$300-\$500	benlseiser@gmail.com
May 16	Lakers Classic	Howard Lake	10U, 12U	C, Rec	\$350	jlblade19@gmail.com
May 16	Wayzata Warmup	Plymouth	8U	A, B, C	\$225	tlyons73@gmail.com
May 16-17	Bluejacket Classic	Cambridge	8U, 10U	A, B, C	\$350	saramattson@msn.com
May 16-17	15th Annual Chisago Lakes Challenge	Lindstrom	10U	B, C	\$475	chisagolakesfastpitch@gmail.com
May 16-17	May Daze	Rochester	10U, 12U	B, C	\$425	ryfsatourney@gmail.com
May 16-17	Jordan Early Summer Bash	Jordan	8U, 10U, 12U, 14U	B, C	\$250-\$450	jordangirlsfastpitch@gmail.com
May 16-17	May Madness	Mankato	10U, 12U	A, B, C	\$450	peppertournaments@gmail.com
May 16-17	Waite Park Summer Classic	Waite Park	10U, 12U	A, B, C	\$325-\$500	brianm@logbank.com
May 16-17	Tonka 8U May Day	Minnetonka	8U	A, B, C	\$350	jessesteinwand@gmail.com

DATE	TOURNAMENT	CITY	AGE	CLASS	ENTRY	EMAIL
May 29-31	Farmington Frenzy	Farmington	8U, 10U, 12U, 14U	A, B, C	\$325-\$500	meredithpeine04@gmail.com
May 29-31	Wayzata Warmup	Plymouth	10U	A, B, C	\$425	tlyons73@gmail.com
May 29-31	Cardinal Classic	Coon Rapids	10U, 12U, 14U, 16/18U	B, C	\$450	coonrapidsfastpitch@gmail.com
May 29-31	36th Annual Fast & Furious	Forest Lake	10U, 12U, 14U	A, B, C	\$500	melissakohoutek@gmail.com
May 29-31	16th Annual Pride in the Pack	Cottage Grove	8U, 10U, 12U	A, B, C	\$250-\$400	charlie.wilwert@cgaasoftball.com
May 30-31	Mini Mayfly	Edina	8U	A, B, C	\$200	mdbush09@gmail.com
May 29-31	Millpond Madness	Baldwin	10U, 12U	A, B, C	\$475	jlmaurer7@gmail.com
May 30-31	Sliding into Summer Classic	Chaska	8U	A, B, C	\$325	lisajdelahunt@gmail.com
May 30-31	Delano Dazzler	Delano	10U, 12U	B, C	\$500	althoff.joey@gmail.com
May 30-31	Kimball Fastpitch	Kimball	10U, 12U	B, C, Rec	\$360	tjj@umn.edu
May 30-31	Behind the Mask	North Mankato	10U, 12U, 14U	B, C	\$375	info@umpiresbehindtheface.com
May 31	Raider Rumble	Northfield	8U	B, C	\$250	topdawgmasonryllc@gmail.com
June 5-7	Bloomington BASH	Bloomington	8U, 10U, 12U, 14U	A, B, C	\$200-\$425	treasurer@bloomingtonfastpitchmn.org
June 5-7	Bison Showdown	Buffalo	10U, 12U, 14U	A, B, C	\$550	president.bgfa@gmail.com
June 5-7	OMGAA Battle on the Turf	Maple Grove	14U	A, B, C	\$425	thetricouple@gmail.com
June 5-7	Wayzata Warmup	Plymouth	12U	A, B, C	\$425	tlyons73@gmail.com
June 5-7	12th Annual Shamrock Showdown	Rosemount	8U, 10U, 12U, 14U, 16/18U	A, B, C	\$490	freis18@yahoo.com
June 5-7	Oriole Opener	St. Louis Park	14U, 16/18U	A, B, C	\$450	david.ritter06@gmail.com
June 5-7	Summer Slam	St. Peter	14U, 16/18U	A, B, C	\$595	kjhmah@yahoo.com
June 5-7	Royal Rumble	Watertown	10U, 12U, 14U	B, C	\$400	lizgerads@gmail.com
June 5-7	16th Annual Bear Classic	White Bear Lake	10U, 12U	B, C	\$475	sheilaevans52309@yahoo.com
June 5-7	Zimmerman Classic Invitational	Zimmerman	8U, 10U, 12U, 14U	A, B, C	\$300-\$500	j.kendle_1985@yahoo.com
June 6	Schools Out	Belle Plaine	12U	A, B	\$400	bpfa.tigers@gmail.com
June 6	Schools Out Round Up	Elk River	8U	A, B, C	\$200	gabriel.fransen@gmail.com
June 5-7	Mendota Heights Masher	Mendota Heights	10U, 12U	C	\$425	tbstevens@gmail.com
June 6-7	Rip Into Summer	Minnetrista	10U	B, C	\$450	nicole.brakstad@gmail.com
June 6-7	Summer Heat	Rochester	10U, 12U, 14U, 16/18U	B, C	\$375	ryfsatourney@gmail.com
June 6-7	Mounds View Madness 12U One Day	Shoreview	12U	A, B, C	\$350	dan.pritchard@comcast.net
June 7	Schools Out	Belle Plaine	8U	A, B	\$300	bpfa.tigers@gmail.com
June 12-14	Soderville Summer Slam	Ham Lake	10U, 12U, 14U, 16U/18U	B, C	\$425	operations@sodervilleblaine.org
June 12-14	8th Annual Spartan Spectacular	Inver Grove Heights	8U, 10U, 12U	A, B, C	\$275-\$425	stransky27@gmail.com
June 12-14	Rock the Ponds	Prior Lake	10, 12U	C	\$425	stevetarahawks@gmail.com
June 12-14	Hudson Border Battle	Hudson	8U, 14U	A, B, C	\$300-\$450	liverm36@hotmail.com
June 12-14	Sting Spring	Edina	10U, 12U	C	\$350	amanda.rosequist@gmail.com
June 13	Royal Rampage	Hopkins	8U	A, B, C	\$200	thofstad13@hotmail.com
June 13	Waite Park 8U Classic	Waite Park	8U	A, B, C	\$275	brianm@logbank.com
June 13-14	15th Annual Chisago Lakes Challenge	Lindstrom	12U	A, B, C	\$475	chisagolakesfastpitch@gmail.com

DATE	TOURNAMENT	CITY	AGE	CLASS	ENTRY	EMAIL
June 13-14	Monti Classic	Monticello	8U, 10U	B, C	\$425	ashley.cyrene@gmail.com
June 13-14	9th Annual Crush Kickstart	Moorhead	10U, 12U, 14U, 16/18U	A, B, C	\$350	dave@moorheadcrush.org
June 13-14	Peppers Showdown	North Mankato	10U, 12U, 14U, 16/18U	C, Rec	\$300	pepperstournaments@gmail.com
June 19-20	Waite Park Summer Classic	Waite Park	14U	A, B, C	\$500	brianm@logbank.com
June 19-21	A-Town Showdown	Andover	10U, 12U, 14U, 16/18U	A, B, C	\$475	ru4sho@yahoo.com
June 19-21	25th Annual Becker Freedom Days	Becker	10U, 12U, 14U	A, B, C	\$450	beckerblast@gmail.com
June 19-21	28th Annual Bemidji Blaze	Bemidji	10U, 12U, 14U, 16/18U	A, B, C	\$200-\$400	caraleenowak@yahoo.com
June 19-21	9th Annual Maddy Nelson Memorial	Cambridge	12U, 14U, 16/18U	A, B, C	\$500	saramattson@msn.com
June 19-21	35th Annual Down 'N Dirty	Eagan	8U, 10U, 12U, 14U, 16U, 18U	A, B, C	\$200-\$400	president@eagansoftball.org
June 19-21	Rising Stars	Mankato	14U, 16U, 18U	B, C	\$600	pepperstournaments@gmail.com
June 19-21	29th Annual Shakopee Father's Day	Shakopee	8U, 10U, 12U	A, B, C	\$200-\$450	steph.kneissel@gmail.com
June 19-21	Shoreview Stampede	Shoreview	14U, 16/18U	A, B, C	\$500	dan.pritchard@comcast.net
June 19-21	Raptor Rampage	Woodbury	8U, 10U	A, B, C	\$400	ryanboatman@gmail.com
June 19-21	Millpond Madness	Baldwin	14U, 16/18U	A, B, C	\$525	jlmaurer7@gmail.com
June 19-21	Border Battle	Hudson	10U, 12U	A, B, C	\$450	liverm36@hotmail.com
June 19-21	Mustang Stampede	Menomonie	8U, 10U, 12U, 14U	B, C	\$250-\$500	sorensenmike2914@gmail.com
June 20	46th Annual Hutchinson Invite	Hutchinson	10U, 12U	Rec	\$290	cburmeister@hutchinsonmn.gov
June 20	Queen of Diamonds	St. Charles	10U, 12U, 14U	B, C	\$300	thegusts654@yahoo.com
June 20-21	Triple Play	Dodge Center	10U, 12U	C, Rec	\$275	trbbond@gmail.com
June 20-21	Windmill Classic	New Ulm	10U, 12U, 14U, 16/18U	B, C	\$375	ajpearson99@hotmail.com
June 20-21	5th Annual Pierz Pioneers	Pierz	10U, 12U, 14U, 16/18U	B, C	\$350	danaiverson24@yahoo.com
June 21	Waite Park Summer Classic	Waite Park	16/18U	A, B, C	\$500	brianm@logbank.com
June 26-28	24th Annual Red Wing Invite	Red Wing	8U, 10U, 12U, 14U, 16/18U	B, C	\$350	levidahling@hotmail.com
June 26-28	Battle Royal	Woodbury	14U, 16/18U	A, B, C	\$450	sbtravel@waawoodbury.org
June 26-28	Bash-A-Rama	Luverne	10U, 12U, 14U, 16/18U	B, C	\$400	michelleraddle@msn.com
June 26-28	Wayzata Warmup	Plymouth	14U, 16U/18U	A, B, C	\$425	tlyons73@gmail.com
June 26-28	Tri County 10-Under Qualifier	Many Locations	10U	A, B, C	\$650	tbye@josoftball.com
June 26-28	Tri County 10-Under Qualifier	Many Locations	12U	A, B, C	\$650	tbye@josoftball.com
June 26-28	Big West 10-Under Qualifier	Many Locations	10U	A, B, C	\$670	dan@mnssoftball.com
June 26-28	Big West 12-Under Qualifier	Many Locations	12U	A, B, C	\$670	dan@mnssoftball.com
June 27-28	Southern Star 10-Under Qualifier	Many Locations	10U	B, C	\$525	southernstarmn@outlook.com
June 27-28	Southern Star 12-Under Qualifier	Many Locations	12U	B, C	\$525	southernstarmn@outlook.com
June 27-28	Minnesota Softball 8-Under State	Many Locations	8U	A, B, C	\$200	tbye@josoftball.com
June 27-28	Under the Lights	Stewartville	10U, 12U, 14U	C, Rec	\$325	stewartvillerebels@gmail.com
June 27-28	Minnewaska Big Wave	Glenwood	10U, 12U, 14U, 16/18U	C, Rec	\$325	chris_roering@hotmail.com
June 27-28	46th Annual Hutchinson Invite	Hutchinson	14U, 16/18U	A, B, C	\$360	cburmeister@hutchinsonmn.gov
June 27-28	Rochester's Royal	Rochester	12U, 14U, 16U/18U	A, B, C	\$450	saronjah@msn.com

DATE	TOURNAMENT	CITY	AGE	CLASS	ENTRY	EMAIL
July 3-5	Peppers Classic	North Mankato	12U, 14U, 16U, 18U	A, B	\$850	peppertournaments@gmail.com
July 10-12	Southwest Slugfest	Marshall	10U, 12U, 14U, 16/18U	B, C	\$300	denaiskruse@hotmail.com
July 11-12	Wildcat Brawl	New London	10U, 12U, 14U, 16U, 18U	C, Rec	\$320	adamjbraegelman@gmail.com
July 11-12	Stars & Strikes	Winona	10U, 12U, 14U	B, C	\$400	winona.winstars@gmail.com
July 12-13	Minnesota Softball 10-Under State	Many Locations	10U	A, B, C	\$250	tbye@mnssoftball.com
July 12-13	Minnesota Softball 12-Under State	Many Locations	12U	A, B, C	\$250	tbye@mnssoftball.com
July 16-19	9th Annual Monsta Championship	Shakopee	8U	A, B, C	\$300	tbye@mnssoftball.com
July 17-19	Showdown on the Prairie	Morris	12U, 14U, 16/18U	A, B, C	\$425	m.kill@plantpioneer.com
July 17-19	Crow River 14-Under Qualifier	Hutchinson	14U	B, C	\$625	crowriverathletics@gmail.com
July 17-19	Crow River 16/18-Under Qualifier	Hutchinson	16/18U	B, C	\$625	crowriverathletics@gmail.com
July 17-19	Tri County 14-Under Qualifier	Many Locations	14U	A, B, C	\$650	tbye@josoftball.com
July 17-19	Tri County 16/18-Under Qualifier	Many Locations	16/18U	A, B, C	\$650	tbye@josoftball.com
July 17-19	Big West 14-Under Qualifier	Many Locations	14U	A, B, C	\$670	dan@mnsoftball.com
July 17-19	Big West 16/18-Under Qualifier	Many Locations	16/18U	A, B, C	\$670	dan@mnsoftball.com
July 18-19	Southern Star 14-Under Qualifier	Many Locations	14U	A, B, C	\$525	southernstarmn@outlook.com
July 18-19	Southern Star 16/18-Under Qualifier	Many Locations	16/18U	A, B, C	\$525	southernstarmn@outlook.com
July 23-26	9th Annual Monsta Championships	Bloomington	10U	A, B, C	\$550	tbye@josoftball.com
July 25-26	Minnesota Softball 14-Under State	Many Locations	14U	A, B, C	\$250	tbye@josoftball.com
July 25-26	Minnesota Softball 16/18-Under State	Many Locations	16/18U	A, B, C	\$250	tbye@josoftball.com
July 30-Aug 2	9th Annual Monsta Championships	Elk River	10U	A, B, C	\$550	tbye@josoftball.com
July 30-Aug 2	9th Annual Monsta Championships	Shoreview	12U	A, B, C	\$550	tbye@josoftball.com
July 31-Aug 2	9th Annual Monsta Championships	Rochester	16/18U	A, B, C	\$550	tbye@josoftball.com
August 6-9	9th Annual Monsta Championships	Mankato	14U	A, B, C	\$550	tbye@josoftball.com
August 14-16	Minnesota Softball Selects	Andover	10U, 12U, 14U, 16/18U	A, B, C	\$85	tbye@josoftball.com
Sept 12-13	Lakeville Fall Classic	Lakeville	10U, 12U	A, B, C	\$500	nicole@lakevillefastpitch.org
Sept 12-13	Fall Frenzy	North Mankato	8U, 10U, 12U, 14U, 16/18U	A, B, C	\$100-\$300	philtos19@gmail.com
Sept 26	Minnesota Softball 8-Under Fall State	Many Locations	8U	A, B, C	\$680	tbye@josoftball.com
Sept 26	Minnesota Softball 10-Under Fall State	Many Locations	10U	A, B, C	\$680	tbye@josoftball.com
Sept 27	Minnesota Softball 12-Under Fall State	Many Locations	12U	A, B, C	\$680	tbye@josoftball.com
Sept 27	Minnesota Softball 14-Under Fall State	Many Locations	14U	A, B, C	\$680	tbye@josoftball.com
Sept 27	Minnesota Softball 16/18-Under Fall State	Many Locations	16/18U	A, B, C	\$680	tbye@josoftball.com



EVERY SEASON STARTS AT



GET THE MOST OUT OF YOUR GEAR.
CHECK OUT OUR IN-STORE SERVICES
AT [DICKS.COM/THEPROS](https://www.dicks.com/thepros)

2025 MINNESOTA SOFTBALL STATE TOURNAMENT RESULTS

Tournament	Champion	Runner Up
Girls Fast Pitch 8-Under Tier 1	Eden Prairie Black (Eden Prairie)	OMGAA Storm (Maple Grove)
Girls Fast Pitch 8-Under Tier 2	Northfield Raiders White (Northfield)	Wayzata Gold (Plymouth)
Girls Fast Pitch 8-Under Tier 3	Stillwater Black (Stillwater)	Soderville Bengals (Blaine)
Girls Fast Pitch 8-Under Tier 4	Waite Park Lehn (Waite Park)	Burnsville Blaze Black (Burnsville)
Girls Fast Pitch 8-Under Tier 5	South St. Paul (South St. Paul)	Stillwater Red (Stillwater)
Girls Fast Pitch 8-Under Tier 6	Eagan White (Eagan)	New Prague Red (New Prague)
Girls Fast Pitch 8-Under Tier 7	River Falls Blue (River Falls)	Cottage Grove White (Cottage Grove)
Girls Fast Pitch 8-Under Tier 8	SCC Menter (Hammond)	Orono Red (Orono)
Girls Fast Pitch 8-Under Tier 9	Elk River Black (Elk River)	Westonka Silver (Minnetrista)
Girls Fast Pitch 10-Under Tier 1	Orono Blue (Orono)	Forest Lake Rangers (Forest Lake)
Girls Fast Pitch 10-Under Tier 2	Lakeville Lightning Blue (Lakeville)	Sartell Blue (Sartell)
Girls Fast Pitch 10-Under Tier 3	Mankato Peppers Sommers (Mankato)	OMGAA Storm (Maple Grove)
Girls Fast Pitch 10-Under Tier 4	Chaska Gold (Chaska)	Stillwater Red (Stillwater)
Girls Fast Pitch 10-Under Tier 5	East Ridge Black (Woodbury)	Soderville Law (Blaine)
Girls Fast Pitch 10-Under Tier 6	Jordan Kaderlik (Jordan)	Byron Black (Byron)
Girls Fast Pitch 10-Under Tier 7	Gamblers White (St. Chales)	Waconia Purple (Waconia)
Girls Fast Pitch 10-Under Tier 8	Twin Ports Rampage (Duluth)	Rocket Orange (Randolph)
Girls Fast Pitch 10-Under Tier 9	New Ulm Vipers Voges (New Ulm)	Farmington Black (Farmington)
Girls Fast Pitch 10-Under Tier 10	Gamblers Yellow (St. Charles)	Rockford Black (Rockford)
Girls Fast Pitch 10-Under Tier 11	Belle Plaine Red (Belle Plaine)	Redwood Rebels Kurtz (Redwood Falls)
Girls Fast Pitch 10-Under Tier 12	Apple Valley Fusion Gray (Apple Valley)	New Prague White (New Prague)
Girls Fast Pitch 10-Under Tier 13	Browntown Cubs Orange (Browntown)	Panther Strikes Maroon (Pine Island)
Girls Fast Pitch 10-Under Tier 14	St. Peter Compart (St. Peter)	Medford Black (Medford)
Girls Fast Pitch 10-Under Tier 15	Hutchinson Gold (Hutchinson)	Chatfield Fireballs Black (Chatfield)
Girls Fast Pitch 12-Under Tier 1	Waconia Gold (Waconia)	Tonka Patton (Minnetonka)
Girls Fast Pitch 12-Under Tier 2	Champlin Park Navy (Champlin)	IGH Red (Inver Grove Heights)
Girls Fast Pitch 12-Under Tier 3	Wilmar Velocity (Wilmar)	Chanhassen Blue (Chanhassen)
Girls Fast Pitch 12-Under Tier 4	Belle Plaine (Belle Plaine)	Farmington Orange (Farmington)
Girls Fast Pitch 12-Under Tier 5	Prescott Tri (Prescott)	Menomonie Jr. Mustangs Maroon (Menomonie)
Girls Fast Pitch 12-Under Tier 6	Aitkin Flying 12's Red (Aitkin)	River Falls Navy (River Falls)
Girls Fast Pitch 12-Under Tier 7	BW Hawks Black (Baldwin)	Buffalo Purple (Buffalo)
Girls Fast Pitch 12-Under Tier 8	FLASC-MCW (Sherburn)	Chisago Lakes Black (Lindstrom)
Girls Fast Pitch 12-Under Tier 9	Kasson-Mantorville Gold (Kasson)	East Ridge White (Woodbury)
Girls Fast Pitch 12-Under Tier 10	St. Peter Baumgarten (St. Peter)	New Ulm Vipers Berdan (New Ulm)
Girls Fast Pitch 12-Under Tier 11	Rochester Reign Maroon (Rochester)	Coon Rapids Black (Coon Rapids)
Girls Fast Pitch 12-Under Tier 12	Shakopee Red (Shakopee)	Kasson-Mantorville Silver (Kasson)
Girls Fast Pitch 12-Under Tier 13	Cleveland Voit (Cleveland)	Dover-Eyota Storm (Eyota)
Girls Fast Pitch 14-Under Tier 1	Waite Park Thompson (Waite Park)	St. Paul Highland Park Reihe (St. Paul)
Girls Fast Pitch 14-Under Tier 2	Titans (Lonsdale)	Revolution Blue (Rockford)
Girls Fast Pitch 14-Under Tier 3	Sartell Blue (Sartell)	Brainerd Bjerkness (Brainerd)
Girls Fast Pitch 14-Under Tier 4	West Metro Prowlers Gold (Waconia)	Orono (Orono)
Girls Fast Pitch 14-Under Tier 5	Sauk Rapids-Rice Green (Sauk Rapids)	Moorhead Crush Orange (Moorhead)
Girls Fast Pitch 14-Under Tier 6	St. Peter Hawker (St. Peter)	Shakopee (Shakopee)
Girls Fast Pitch 14-Under Tier 7	Redwood Rebels (Redwood Falls)	Kimball Gold (Kimball)
Girls Fast Pitch 14-Under Tier 8	Parkers Prairie Pink Panthers (Parkers Prairie)	DGF Black (Dilworth)
Girls Fast Pitch 16/18U Tier 1	Waite Park Sheetz (Waite Park)	MN Express (North Mankato)
Girls Fast Pitch 16/18U Tier 2	Kimball (Kimball)	Annandale Black (Annandale)
Girls Fast Pitch 16/18U Tier 3	MN Freeze (St. Peter)	American Legion Post #145 (Howard Lake)
Girls Fast Pitch 16/18U Tier 4	Sleepy Eye Whales (Sleepy Eye)	Lakers Area Lasers (Pequot Lakes)
Girls Fast Pitch 16/18U Tier 5	Hawley (Hawley)	Hutchinson (Hutchinson)
Girls Fast Pitch Fall 8-Under Tier 1	Champlin Park Navy (Champlin)	Chaska Purple (Chaska)
Girls Fast Pitch Fall 8-Under Tier 2	Mankato Schloesser (Mankato)	Andover White (Andover)
Girls Fast Pitch Fall 8-Under Tier 3	Edina Hornets (Edina)	Eden Prairie Black (Eden Prairie)
Girls Fast Pitch Fall 8-Under Tier 4	Stillwater Black (Stillwater)	Prescott (Prescott)
Girls Fast Pitch Fall 8-Under Tier 5	Crow River Kley (Hutchinson)	Jordan Arvin (Jordan)
Girls Fast Pitch Fall 8-Under Tier 6	Tonka Robinson (Minnetonka)	Westonka White (Minnetrista)

Girls Fast Pitch Fall 8-Under Tier 7	Brooklyn Park Pirates (Brooklyn Park)	Burnsville Yellow (Burnsville)
Girls Fast Pitch Fall 10-Under Tier 1	Forest Lake Rangers Elite (Forest Lake)	ROSA Black (Rogers)
Girls Fast Pitch Fall 10-Under Tier 2	Champlin Park Navy (Champlin)	Farmington Buck/Fenske (Farmington)
Girls Fast Pitch Fall 10-Under Tier 3	Chisago Lakes Green (Lindstrom)	Chaska Yellow (Chaska)
Girls Fast Pitch Fall 10-Under Tier 4	East Ridge Gold (Woodbury)	Lakeville Hafermann (Lakeville)
Girls Fast Pitch Fall 10-Under Tier 5	Coon Rapids Black (Coon Rapids)	Ellsworth Purple (Ellsworth)
Girls Fast Pitch Fall 10-Under Tier 6	Prescott Black (Prescott)	Prior Lake Gold (Prior Lake)
Girls Fast Pitch Fall 10-Under Tier 7	Randolph Rockets (Randolph)	South St. Paul Packers (South St. Paul)
Girls Fast Pitch Fall 10-Under Tier 8	Becker Blast White (Becker)	Crow River Nelson (Hutchinson)
Girls Fast Pitch Fall 10-Under Tier 9	Burnsville Black (Burnsville)	Satell White (Sartell)
Girls Fast Pitch Fall 10-Under Tier 10	Apple Valley Fusion White (Apple Valley)	Grantsburg (Grantsburg)
Girls Fast Pitch Fall 10-Under Tier 11	Somerset Black (Somerset)	Hudson Blue (Hudson)
Girls Fast Pitch Fall 10-Under Tier 12	Hastings Blue (Hastings)	Prior Lake Navy (Prior Lake)
Girls Fast Pitch Fall 10-Under Tier 13	River Falls Silver (River Falls)	Big Lake Gold (Big Lake)
Girls Fast Pitch Fall 10-Under Tier 14	Rosemount Gray (Rosemount)	St. Paul Highland Park (St. Paul)
Girls Fast Pitch Fall 10-Under Tier 15	Crow River Breyer (Hutchinson)	Lakeville Moore (Lakeville)
Girls Fast Pitch Fall 12-Under Tier 1	ROSA Black (Rogers)	Shakopee Black (Shakopee)
Girls Fast Pitch Fall 12-Under Tier 2	Bloomington Blast Blue (Bloomington)	Wayzata Sriharan (Plymouth)
Girls Fast Pitch Fall 12-Under Tier 3	New Richmond Black (New Richmond)	Northfield Raiders Maroon (Northfield)
Girls Fast Pitch Fall 12-Under Tier 4	OMGAA B1 (Maple Grove)	Centennial Lakes Heagle (Circle Pines)
Girls Fast Pitch Fall 12-Under Tier 5	Rosemount Blue (Rosemount)	Anoka-Ramsey Maroon (Anoka)
Girls Fast Pitch Fall 12-Under Tier 6	Ellsworth Purple (Ellsworth)	Mahtomedi Wethern (Mahtomedi)
Girls Fast Pitch Fall 12-Under Tier 7	Crow River Kveene (Hutchinson)	Stillwater Red (Stillwater)
Girls Fast Pitch Fall 12-Under Tier 8	Mankato Peppers Kolsrud (Mankato)	Baldwin-Woodville Hawks Black (Baldwin)
Girls Fast Pitch Fall 12-Under Tier 9	Crow River Brown (Hutchinson)	Chanhassen White (Chanhassen)
Girls Fast Pitch Fall 12-Under Tier 10	Belle Plaine Red (Belle Plaine)	Northfield Raiders Gold (Northfield)
Girls Fast Pitch Fall 12-Under Tier 11	Champlin Park White (Champlin)	Richfield Cardinal (Richfield)
Girls Fast Pitch Fall 12-Under Tier 12	Fairmont Cardinal Power Terfehr (Fairmont)	New Prague Red (New Prague)
Girls Fast Pitch Fall 12-Under Tier 13	South St. Paul Packers (South St. Paul)	Rosemount Green (Rosemount)
Girls Fast Pitch Fall 12-Under Tier 14	Wayzata Vickerman (Plymouth)	Roseville White (Roseville)
Girls Fast Pitch Fall 14-Under Tier 1	MN Knights (Albertville)	Big Lake McCormack (Big Lake)
Girls Fast Pitch Fall 14-Under Tier 2	Shell Lake Slam (Shell Lake)	East Ridge Black (Woodbury)
Girls Fast Pitch Fall 14-Under Tier 3	Rosemount Gold (Rosemount)	IGH Red (Inver Grove Heights)
Girls Fast Pitch Fall 14-Under Tier 4	MN Elks (Elk River)	Central MN Athletics (Maple Lake)
Girls Fast Pitch Fall 14-Under Tier 5	MN Havoc (Jackson)	612 Minneapolis Navy (Minneapolis)
Girls Fast Pitch Fall 14-Under Tier 6	Cumberland Bussewitz (Cumberland)	West Metro Prowlers Purple (Waconia)
Girls Fast Pitch Fall 14-Under Tier 7	Eagan White (Eagan)	Andover Black (Andover)
Girls Fast Pitch Fall High School Tier 1	Kimball Cubs (Kimball)	MN Elks (Elk River)
Girls Fast Pitch Fall High School Tier 2	River City Rush (Zimmerman)	Wayzata Gold (Plymouth)
Girls Fast Pitch Fall High School Tier 3	Crow River Main (Hutchinson)	Rosemount Gold (Rosemount)
Girls Fast Pitch Fall High School Tier 4	Crow River Sneller (Hutchinson)	MN Havoc (Jackson)
Girls Fast Pitch Fall High School Tier 5	New Ulm (New Ulm)	St. Peter (St. Peter)

For a list of all state champions dating back to 1916, please go to our softball history website at <http://www.softballhistorymn.com/>.



SINCE 1995



**Custom Screenprinting, Embroidery,
Trophies & Sporting Goods**

“YOUR ONE STOP SHOP”

www.tahosportswear.com

BEST PRICING ON:

- **APPAREL**
- **EVENT WEAR**
- **BANNERS**
- **DECALS**
- **ONLINE TEAM STORE**
- **TROPHIES & AWARDS**
- **SPORTS EQUIPMENT**

OFFICIAL PARTNER OF



SIMPLIFIED SCORING INSTRUCTIONS

PLAYER'S FIELDING PERFORMANCE

Inning by inning the scorekeeper will credit the positions shown 1 thru 10 with put-out assist or errors, noting any fielding changes.

ON THE MOUND

No.	PLAYERS	POS. Inn	THE PLAYERS POSITION AND INNING PLAYED										Total number of At Bats, Hits, and Runs Batted In (RBI's) for player per game.							
			1	2	3	4	5	6	7	8	9	AB	H	RBI						
1	4 J. SMITH																			
2																				
3																				
			RUNS HITS		RUNS HITS		RUNS HITS		RUNS HITS		RUNS HITS		RUNS HITS		RUNS HITS		RUNS HITS		RUNS HITS	
			Total number of Hits/Runs per inning.												Total number of At Bats, Hits, and Runs Batted In (RBI's) for team per game.					

EXAMPLE OF A FILLED OUT BOX

The batter's accomplishment is shown on the top of the base layout. **EXAMPLE: The batter made a double.**

Cross off the corresponding numbers for balls and strikes for each player here. **EXAMPLE: The count on the batter is 1 ball and 2 strikes.**

The center portion of the base layout is used to show pictorially the type of hit ball, where it was hit, and if it resulted in a put-out, a hit, or a fielding error. **EXAMPLE: Batter hits a double to the left field corner and scoring the two (2) base runners in front of him.**

Indicates Errors, Fielders Choice, and Sacrifice Bunt.

When a batter strikes out, fill in the "OUT" box when an out is made in an inning.

POSITIONS

- 1- Pitcher
- 2- Catcher
- 3- First Base
- 4- Second Base
- 5- Third Base
- 6- Short Stop
- 7- Left Fielder
- 8- Center Fielder
- 9- Right Fielder

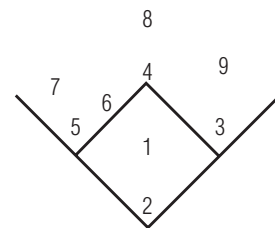

RECORDING NUMBER OF INNINGS PITCHED:

Inning by inning the scorekeeper will write in the uniform number of the pitcher on the mound.

SYMBOL

IP- Innings Pitched AB- At Bats H- Hits Allowed R- Runs Allowed ER-Earned Runs Allowed
BB- Base on Balls SO- Shut Out S- Substitute

↙ Pitching Win/Pitching Loss

NO	W	L	S	PITCHERS				IP	AB	H	R	ER	BB	SO
2			6/3	A. Clark				2						

↑ Pitchers Number

↑ The relief pitcher's uniform number is added to the "S" column with the inning replaced. **EXAMPLE: Sub Pitcher's # / Inning Entered.**

SYMBOLS & ABBREVIATIONS

BATTER REACHES BASE WITHOUT THE VIRTUE OF A SAFE HIT

STRIKE OUT WILD PITCH	STRIKE OUT PASSED BALL	ERROR	FIELDER'S CHOICE	HIT BY PITCH	CATCHES INTERFERENCE	BASE ON BALLS
OFFICIAL TIME AT BAT				NOT OFFICIAL TIME AT BAT		

Runner advances a base without the aid of a batted ball. Shown by a dark line with the symbol that best describes the reason the runner advances.

SYMBOL
SB- Stolen Base WP- Wild Pitch PB- Passed Ball E- Error BK- Balk

BATTER REACHES BASE WITH THE VIRTUE OF A SAFE HIT

SINGLE	BUNT SINGLE	BATTED BALL HITS RUNNER	DOUBLE	TRIPLE	HOME RUN
OFFICIAL TIME AT BAT					

The batter is credited with an RBI for each runner that scores by virtue of . . .

SYMBOL
BB- Base on Balls HP- Hit by Pitch BK- Balk FC- Fielder's Choice
SAC- Sacrifice Fly E- Error: When, in the judgement of the scorer, the runner would have scored if the ball was fielded cleanly.

BATTER TURN AT BAT RESULTS IN AN OUT

STRIKE OUT LOOKING	STRIKE OUT SWINGING	PUT OUT UNASSIGNED	PUT OUT ASSISTED	DOUBLE PLAY	BATTER INTERFERENCE	*SACRIFICE BUNT	*SACRIFICE FLY
OFFICIAL TIME AT BAT						NOT OFFICIAL TIME AT BAT	

*SACRIFICE BUNT: when the bunted ball advances a runner or runners on base.

*SACRIFICE FLY: When the fly ball scores the runner from third.

TEAM RECORD GAME START TIME GAME END TIME

No.	PLAYERS	POS. Inn	1	2	3	4	5	6	7	8	9	AB	H	RBI
1														
2														
3														
4														
5														
6														
7														
8														
9														
10														
11														
12														
13														
14														
15														
16														
			RUNS / HITS	RUNS / HITS	RUNS / HITS	RUNS / HITS	RUNS / HITS	RUNS / HITS	RUNS / HITS	RUNS / HITS	RUNS / HITS			
			ER E LOB	ER E LOB	ER E LOB	ER E LOB	ER E LOB	ER E LOB	ER E LOB	ER E LOB	ER E LOB			

8

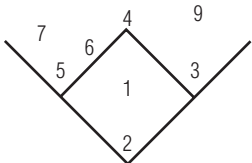

NO	W	L	S	PITCHERS	IP	AB	H	R	ER	BB	SO



Play Ball!

IN THE TWIN CITIES GATEWAY



Welcome to the Twin Cities Gateway for the Tournament. Be sure to check out the many fine lodging properties in the Gateway.

Good luck and enjoy your stay!



**TWIN CITIES
GATEWAY**



Scan here to plan your next Gateway Event

Anoka • Arden Hills • Blaine • Coon Rapids • Fridley • Ham Lake
Lino Lakes • Mounds View • New Brighton • Shoreview

MINNESOTA **SOFTBALL**

PARADE OF CHAMPIONS

SUNDAY, AUGUST 16TH, 2026 AT 1:10 PM



Come celebrate your championship with your teammates and the Minnesota Twins with a pregame parade on the field. Uniforms are encouraged! Parade lineup will begin at 11:45 a.m.

Tickets—\$25.00

Please contact Ryan Thomson for tickets

ryanthomson@twins.com

612-659-3582

TM

MINNESOTA SOFTBALL FAST PITCH RULEBOOK

TABLE OF CONTENTS

RULE 1 - DEFINITIONS	4
RULE 2 – PLAYING FIELD	7
SECTION 1 – THE PLAYING FIELD	7
SECTION 2 - GROUNDS	7
SECTION 3 - LAYOUT	7
RULE 3 - EQUIPMENT	9
SECTION 1 - OFFICIAL BAT	10
SECTION 2 - WARM-UP BAT	10
SECTION 3 - OFFICIAL SOFTBALL	11
SECTION 4 - GLOVE/MITT	11
SECTION 5 - CATCHER'S EQUIPMENT, FACE MASK/GUARDS AND HELMET	12
SECTION 6 - UNIFORM	13
SECTION 7 - ALL EQUIPMENT	13
RULE 4 – PLAYERS, COACHES, SUBSTITUTES	14
SECTION 1 - PLAYERS	14
SECTION 2 - AMERICAN DISABILITY ACT RULE	15
SECTION 3 - DESIGNATED PLAYER (Fast Pitch)	15
SECTION 4 - EXTRA PLAYER	16
SECTION 5 - RE-ENTRY	16
SECTION 6 - SUBSTITUTES/ILLEGAL PLAYER	16
SECTION 7 - COACH	17
SECTION 8 - DISQUALIFIED OR EJECTED PARTICIPANT	18

SECTION 9 - BLOOD RULE	18
SECTION 10 - INJURED PLAYER	18
RULE 5 - THE GAME	18
SECTION 1 - HOME TEAM	18
SECTION 2 - FITNESS OF THE GROUNDS	18
SECTION 3 - REGULATION GAME	18
SECTION 4 – FORFEITED GAMES	18
SECTION 5 - SCORING OF RUNS	19
SECTION 6 - GAME WINNER	19
SECTION 7 - CONFERENCES	19
SECTION 8 - RUN AHEAD RULE	19
SECTION 9 - TIME LIMIT WITH ADDITIONAL INNING RULE	19
SECTION 10 - TIE-BREAKER RULE	19
SECTION 11 - DUGOUT AND ON FIELD CONDUCT	20
RULE 6 - PITCHING REGULATIONS	20
SECTION 1 – PRELIMINARIES	20
SECTION 2 - STARTING THE PITCH	20
SECTION 3 - LEGAL DELIVERY	20
SECTION 4 - INTENTIONAL WALK	21
SECTION 5 – DEFENSIVE POSITIONING	21
SECTION 6 - FOREIGN SUBSTANCE/PROTECTIVE WRAPS	21
SECTION 7 - CATCHER	21
SECTION 8 - THROWING TO A BASE	21
SECTION 9 - WARM-UP PITCHES	21
SECTION 10 - NO PITCH	21
SECTION 11 - ILLEGAL PITCH PENALTY	22

RULE 7 - BATTING	22	SECTION 6 - WRITTEN PROTESTS	34
SECTION 1 - ON-DECK BATTER	22	SECTION 7 - RESULTS OF PROTEST	34
SECTION 2 - BATTING ORDER.....	22	RULE 10 - UMPIRES	34
SECTION 3 - BATTING POSITION.....	23	SECTION 1 - POWER AND DUTIES.....	34
SECTION 4 - A STRIKE ON THE BATTER.....	23	SECTION 2 - CHANGE OF UMPIRES.....	34
SECTION 5 - A BALL ON THE BATTER.....	23	SECTION 3 - UMPIRE’S JUDGMENT	34
SECTION 6 - THE BATTER IS OUT	24	SECTION 4 - SUSPENSION OF PLAY.....	34
RULE 8 - BATTER-RUNNER AND RUNNER	25	RULE 11 - SCORING	34
SECTION 1 - THE BATTER BECOMES A BATTER-RUNNER	25	SECTION 1 - OFFICIAL SCORER.....	35
SECTION 2 - THE BATTER-RUNNER IS OUT	26	SECTION 2 - THE BOX SCORE	35
SECTION 3 - TOUCHING BASES IN LEGAL ORDER	27	SECTION 3 - BASE HITS	36
SECTION 4 - RUNNERS ARE ENTITLED TO ADVANCE WITH LIABILITY TO BE PUT OUT	27	SECTION 4 - RUNS BATTED	36
SECTION 5 - RUNNERS ARE ENTITLED TO ADVANCE WITHOUT LIABILITY TO BE PUT OUT.....	27	SECTION 5 - PITCHER CREDITS.....	36
SECTION 6 - A RUNNER MUST RETURN TO THEIR BASE	29	SECTION 6 - PITCHER LOSSES	36
SECTION 7 - THE RUNNER IS OUT.....	29	SECTION 7 - THE SUMMARY.....	36
SECTION 8 - THE RUNNER IS NOT OUT.....	32	SECTION 8 - STOLEN BASES	36
SECTION 9 - ADULT SLOW PITCH / MASTERS AND SENIOR FAST PITCH ...	32	SECTION 9 - FORFEITED GAMES	36
SECTION 10 - COURTESY RUNNERS.....	32	SECTION 10 - TIE BREAKER RULE	37
RULE 9 – PROTESTS	33	RULE 12 - USE OF USA SOFTBALL PLAYING RULES	37
SECTION 1 - TYPES OF PROTESTS	33	RULES SUPPLEMENT	37
SECTION 2 – PROTESTS NOT CONSIDERED	33	1 - APPEALS.....	37
SECTION 3 – PROTESTS ALLOWED	33	2 - BALL ROTATION PROCEDURE.....	38
SECTION 4 - PROTEST NOTIFICATION.....	33	3 - BAT WITH DENTS, RATTLES, EXCESSIVE WEAR OR DELAMINATIONS. COMPRESSION TESTING PSI REQUIREMENTS	38
SECTION 5 - PROTESTS OF ELIGIBILITY	34	4 - BATTING WITH AN ILLEGAL, ALTERED, OR NON-APPROVED BAT	39
		5 - BATTER REMAINS IN BATTER’S BOX.....	39

6 - BATTING ORDER IS OFFICIAL	39	32 - LOOK BACK RULE	44
7 - BATTING OUT OF THE BATTER'S BOX.....	39	33 - MEDIA COVERAGE	45
8 - CATCHER'S BOX	39	34 - OBSTRUCTION.....	45
9 - CHARGED CONFERENCES	39	35 - OVERRUNNING FIRST BASE	46
10 - CHECK SWING/BUNT STRIKE	39	36 - OVERTHROWS.....	46
11 - COMMUNICATION / ELECTRONIC DEVICES.....	40	37 - PASSING A RUNNER	46
12 - COURTESY RUNNER	40	38 - PITCHING	46
13 - CRASHING INTO A FIELDER WITH THE BALL (Interference)	40	39 - PITCHER'S UNIFORM.....	47
14 - DELAYED DEAD BALL.....	40	40 - PROTESTED GAME UPHELD AND RESUMED.....	47
15 - DESIGNATED PLAYER OR DP	40	41 - RUN SCORING ON THE THIRD OUT OF AN INNING	47
16 - DUGOUT CONDUCT	41	42 - RUNNER HIT BY A FAIR BATTED BALL	47
17 - EQUIPMENT ON THE PLAYING FIELD.....	41	43 - RUNNERS SWITCHING POSITIONS ON THE BASE PATH.....	48
18 - EXTRA PLAYER OR EP (Pool Play).....	41	44 - SHOES	48
19 - FAKE TAG	42	45 - SHORTHANDED TEAMS (Starting the Game).....	48
20 - FALLING OVER THE FENCE ON A CATCH.....	42	46 - SHORTHANDED TEAMS (Continuing after Starting with Full Team)..	48
21 - FORCE OUT	42	47 - SPORTING BEHAVIOR.....	48
22 - FOUL BALL/FOUL TIP	42	48 - SUBSTITUTIONS	48
23 - GLOVE/MITT (Using an Illegal Glove/Mitt).....	42	49 - THROWING OR CARRYING A BAT	49
24 - HITTING THE BALL A SECOND TIME.....	42	50 - TIE GAMES OR GAMES CALLED WHICH ARE LESS THAN REGULATION	49
25 - HOME RUNS/FOUR BASE AWARDS/TWO BASE AWARDS.....	43	51 - TIE BREAKER RULE	49
26 - IMAGINARY LINE OR DEAD BALL AREA.....	43	52 - WHEEL CHAIR USE	49
27 - INFIELDER	43		
28 - INJURED PLAYER	43		
29 - INTENTIONALLY DROPPED BALL.....	43		
30 - INTENTIONAL WALK	43		
31 - INTERFERENCE.....	43		

RULE 1 - DEFINITIONS

ALTERED BAT: When the physical structure of a legal softball bat has been changed.

APPEAL PLAY: A play on a rule violation on which an umpire may not decide until requested by a manager, coach, or player.

BALL COMPRESSION: The load force, in pounds, required to compress a softball 0.250 inches when measured in accordance with the ASTM test method for measuring compression-displacement of softballs.

BALL COR: The coefficient of restitution of a softball when measured in accordance with the ASTM test method for measuring coefficient of restitution of softballs.

BASE ON BALLS: Permits a batter to gain first base when four pitches are judged to be out of the strike zone.

BASE LINE: An imaginary line directly between bases.

BASE PATH: A line directly between a base and the runner's position at the time a defensive player is attempting to tag that runner.

BATTED BALL: Any pitched ball that hits the bat or is hit by the bat and lands either in fair territory or foul territory.

BATTER'S BOX: The area to which the batter is restricted when batting.

BATTER-RUNNER: A player who has completed a turn at bat but has not yet been put out or reached first base.

BATTING ORDER: The official listing of offensive players in the order in which they bat.

BLOCKED BALL: A batted, pitched or thrown ball that is touched, stopped, or handled by a person not engaged in the game, or which touches loose equipment or any object that is not part of the official equipment or official playing area.

BLOOD RULE: Refers to a player, coach or umpire who is bleeding or who has blood on their uniform and treatment is required.

BUNT: A pitched ball that is intentionally tapped with the bat, slowly, within the infield.

CATCH/NO CATCH:

- A. A catch is a legally caught ball, which occurs when the fielder catches a batted, pitched or thrown ball with the hand(s) or glove/mitt.
1. To establish a valid catch, the fielder shall hold the ball long enough to prove control of it and/or that the release of the ball is voluntary.

2. If the ball is merely held in the fielder's arm(s) or prevented from dropping to the ground by some part of the fielder's body, equipment or clothing, the catch is not completed until the ball is in the grasp of the fielder's hand(s) or glove/mitt.
 3. The fielder's feet must be within the field of play, touching the "out of play" line or in the air after leaving live ball territory to have a valid catch. A player who is "out of play" and returns must have both feet touching live ball territory or one foot touching and the other in the air, for the catch to be legal.
- B. It is not a catch:
1. If a fielder, while gaining control, collides with another player, umpire, or a fence, or falls to the ground and drops the ball because of the collision or falling to the ground.
 2. If a ball strikes anything other than a defensive player while it is in flight it is the same as if it struck the ground.
 3. When a fielder catches a batted or thrown ball with anything other than the hand(s) or glove/mitt in its proper place.

CATCH AND CARRY: A legal catch followed by a defensive player carrying the ball into dead ball territory.

CATCHER'S BOX: The area to which the catcher is restricted while catching. The catcher must remain in the box until the pitch is released.

CHAMPIONSHIP PLAY: When used in the USA Softball Playing Rules, the term "Championship Play" shall have the same meaning as is assigned to such term by the USA Softball Code.

CHARGED CONFERENCE: When a team representative requests a suspension of play or delays the game for the purpose of delivering a message to another team member unless the pitcher is removed from the pitching position.

COACH: A person who occupies the coach's box and/or assists in the direction of their team representatives on the field.

COACH'S BOX: The area in which the base coach is restricted to prior to the release of the pitch.

COURTESY RUNNER: Any player who runs for a runner without a charged substitution.

CROW HOP: The act of a pitcher who steps, hops, or drags off the front of the pitcher's plate, replants the pivot foot, thereby establishing a second impetus, or starting point, pushes off from the newly established starting point and completes the delivery.

DEAD BALL: A ball that is not in play.

DEFENSIVE TEAM: The team in the field.

DESIGNATED PLAYER (DP): The player who is initially on the line-up card in the team's batting order but not in the defensive line-up.

DISLODGED BASE: A base displaced from its proper position.

DISQUALIFIED PLAYER: A player removed from the game for a rule violation.

DOUBLE PLAY: A play in which two offensive players are legally put out because of continuous action.

DUGOUT/TEAM AREA: An out-of-play area designated for players and team representatives.

EJECTED PARTICIPANT: A team representative removed from the game by the umpire, usually for an unsportsmanlike act or conduct.

EXTRA PLAYER (EP): An optional player(s) in these games.

FAIR BALL: A legally batted ball that:

- A. Settles or is touched on or over fair territory between home and first base or between home and third base.
- B. Bounds over or past first or third base, which is in fair territory, regardless of where the ball hits after going over the base.
- C. While on or over fair territory, touches the person, attached equipment or clothing of a player or an umpire.
- D. While over fair territory, an offensive player interferes with a defensive player attempting to field a batted ball.
- E. Touches first, second or third base.
- F. First falls or is first touched on or over fair territory beyond first, second or third base.
- G. While over fair territory, leaves the playing field beyond the outfield fence.
- H. Hits the foul pole.

FAIR TERRITORY: That part of the playing field within, and including, the first and third base foul lines from home plate to the bottom of the playing field fence and perpendicularly upwards.

FAKE TAG: A form of obstruction by a fielder who attempts to tag a runner without the ball and thereby impedes a runner advancing or returning to a base.

FIELDER: Any player of the team in the field.

FLEX: The player who is initially listed in the tenth spot or the last spot in JO Pool Play when batting more than 9 on the line-up card, and may play any defensive position, and may enter the game on offense only in the Designated Player's (DP) batting position.

FLY BALL: A batted ball, fair or foul, that rises into the air.

FORCE OUT: An out which may be made only when a runner loses the right to the base that the runner is occupying because the batter becomes a batter-runner, and before the batter-runner or a trailing runner has been put out.

FOUL BALL: A batted ball that:

- A. Settles or is touched (not caught) on or over foul territory between home and first base or between home and third base.
- B. Bounds or rolls past first or third base, on or over foul territory.
- C. While over foul territory, touches the person, attached or detached equipment or clothing of a player or an umpire, or any object foreign to the natural ground.
- D. While over foul territory, an offensive player interferes with a defensive player attempting to field a batted ball.
- E. First hits the ground over foul territory beyond first or third base.
- F. Touches the batter or the bat in the batter's hand(s) a second time while the batter is within the batter's box.
- G. Goes directly from the bat to any part of the catcher's body or equipment and is caught by another fielder.
- H. Hits the pitcher's plate and rolls untouched to foul territory before reaching first or third base.

FOUL TIP: A batted ball that goes sharply and directly from the bat to the catcher's hand(s) or glove/mitt and is legally caught by the catcher.

HOME TEAM: The team that starts the game on defense.

ILLEGAL BAT: A bat that does not meet the requirements of an official bat or warm-up bat.

ILLEGALLY BATTED BALL: Occurs when the batter hits the ball fair or foul and:

- A. At the time the bat contacts the ball, the entire foot is completely outside the lines of the batter's box and on the ground.
- B. At the time the bat contacts the ball, any part of the foot is touching home plate.
- C. An illegal, altered, or non-approved bat is used.
- D. At the time the bat contacts the ball, the batter's entire foot has contacted the ground out of the batter's box and returned to hit the ball while inside the box.

ILLEGAL PLAYER: A player who takes a position in the line-up, either on offense or defense, who does not have a legal right to that position.

IN FLIGHT: The term used for any batted, thrown, or pitched ball which has not yet touched the ground or some object or person other than a fielder.

IN JEOPARDY: A term indicating that the ball is in play and an offensive player may be put out.

INELIGIBLE PLAYER: A player who does not meet the requirements of the USA Softball Code.

INFIELD: That portion of the field in fair territory that includes areas normally covered by infielders.

INFIELDER: A fielder who defends the area of the field around first, second, third, or shortstop areas.

INFIELD FLY: A fair fly ball, not including a line drive or an attempted bunt, which can be caught by an infielder, pitcher, or catcher with ordinary effort when first and second or first, second and third bases are occupied with less than two outs.

INNING: That portion of a game within which the teams alternate on offense and defense and in which there are three outs for each team. A new inning or half inning begins immediately after the final out of the previous inning or half inning.

INTERFERENCE: The act of an offensive player or team member, umpire or spectator that impedes, hinders, or confuses a defensive player attempting to execute a play. Contact is not necessary.

JUNIOR OLYMPIC PLAYER: Any player eligible to participate in the Junior Olympic program. If Junior Olympic players play on an adult team, it is considered playing in an adult league and adult rules will be in effect.

Warning: If a Junior Olympic player elects to play on an adult team and be subject to adult rules, players may be subject to a heightened risk of injury because of: (A) a potential disparity in the skill level, weight, and size of players; and/or (B) adult rules not mandating certain requirements or protective equipment.

LINE DRIVE: A batted ball that travels parallel or near the ground through most of its flight.

LINE-UP CARD: The official document listing starting players and substitutes of a given team.

MANAGER: The team representative that must always have control of their team on and off the field.

NON-APPROVED BAT: A bat that does not meet USA Softball specifications or is on the current USA Softball non-approved bat list with USA Softball Certification Mark.

OBSTRUCTION: The act of a defensive team member:

- A. Who hinders or impedes a batter from striking at or hitting a pitched ball.
- B. Who impedes the progress of a runner or batter-runner who is legally running the bases unless the fielder is;
 1. in possession of the ball.

2. in the act of fielding a batted ball.

Note: Contact is not necessary to impede the progress of the batter-runner or a runner.

OFFENSIVE TEAM: The team at bat.

ON-DECK BATTER: The offensive player who is scheduled to bat next.

ON-DECK CIRCLE: The area nearest the offensive team's dugout in which the next batter is restricted to before the release of the pitch.

OUTFIELD: That portion of the field in fair territory which is normally covered by outfielders.

OUTFIELDER: A fielder who defends the area of the field that the left, left-center, right-center, and right fielders normally play.

OVER SLIDE: The act of an offensive player when, as a runner, slides beyond or loses contact with a base the player is attempting to reach.

OVERTHROW: A thrown ball from a fielder that goes:

- A. Beyond the boundary lines of the playing field (dead ball territory), or
- B. Becomes a blocked ball.

PARTICIPANT: A starting player, substitute, manager, coach, or another team representative located in the dugout, team area or playing field.

PASSED BALL: A legally delivered pitch that should have been held or controlled by the catcher with ordinary effort.

PIVOT FOOT: The foot which must remain in contact with the pitcher's plate prior to pushing off.

PLAY: An attempt by a defensive player to retire an offensive player. A pitch is not considered a play except as it relates to an appeal.

PLAY BALL: The term used by the plate umpire to indicate that play shall start.

PROTEST: A formal request to review the decision of an umpire's rule interpretation.

QUICK PITCH: A pitch made with the obvious attempt to catch the batter off balance.

RUNNER: An offensive player who has reached first base and has not yet been put out or scored.

SACRIFICE FLY: Scored when, with fewer than two outs, the batter scores a runner with a fly ball or line drive that is:

- A. Caught.
- B. Dropped by any fielder and, in the scorer's judgment, the runner could have scored after the catch had the fly ball or line drive been caught.

STARTING PLAYER: A player listed on the line-up card that is inspected and approved by the plate umpire.

STEALING: The act of a runner attempting to advance during a pitch. Runners can advance once the pitched ball leaves the pitcher's hand.

STRIKE ZONE: That space over any part of home plate when a batter assumes a natural batting stance adjacent to home plate. Between the batter's arm pits and the top of the knees.

SUBSTITUTE: Any member of a team's roster who is not listed as a starting player, or a player who leaves and re-enters the game.

TAG: A legal tag is the act of a defensive player:

- A. Touching a base with any part of the body while holding the ball securely and firmly in the hand or glove or:
- B. Touching the runner or batter-runner with the ball while securely held in the hand or glove.

TIME: The term used by the umpire to suspend play.

TRIPLE PLAY: A play by the defense in which three offensive players are legally put out because of continuous action.

TURN AT BAT: When a player first enters the batter's box and continues until the player is substituted for, put out, or becomes a batter-runner while at bat.

WILD PITCH: A legally delivered pitch that the catcher cannot catch or stop and control with ordinary effort.

RULE 2 – PLAYING FIELD

SECTION 1 – THE PLAYING FIELD

The playing field is the area within which the ball may be legally played and fielded. There shall be a clear and unobstructed area between the foul lines and within the radius of the prescribed fence distances from home plate.

Division	Bases	Pitching	Min. Fence	Max. Fence
G10-U-A/B	60'	35'	175'	225'
G12-U-A/B	60'	40'	200'	225'

G14-U-A/B	60'	43'	200'	225'
G16-U-A/B	60'	43'	200'	225'
G16-U-Gold	60'	43'	200'	225'
G18-U-A/B	60'	43'	200'	225'
G18-U-Gold	60'	43'	200'	225'

Note: In Junior Olympic Fast Pitch 8 - Under, the region hosting the Regional Championship Finals will establish the base, pitching, and fence distance as well as other sections of the USA Softball Playing Rules.

If the base distances or the pitching distance is found to be at the wrong dimensions during the game, correct the error, with no penalty, and continue playing the game. Every effort should be made by the umpire to obtain the correct dimensions.

SECTION 2 - GROUNDS

Ground or special rules establishing the limits of the playing field may be established by tournament officials. Any obstruction in fair ground less than the prescribed fence distances from home plate should be clearly marked for the umpire's information. If using a baseball field, the mound should be removed, and the backstop distances must meet those prescribed (minimum of 25 feet or a maximum of 30 feet from home plate).

SECTION 3 - LAYOUT

For the layout of the diamond, refer to the drawing showing the official dimensions for a softball diamond. This section serves as an example for laying out a diamond with 60-foot bases and a 46-foot pitching distance. To determine the position of home plate, draw a line in the direction desired to lay out the diamond. Drive a stake at the corner of home plate nearest the catcher. Fasten a cord to this stake and tie knots, or otherwise, mark the cord, at 46 feet, 60 feet, 84 feet 10 1/4 inches, and at 120 feet. Place the cord (without stretching) along the direction line and place a stake at the 46-foot marker. This will be the front line at the middle of the pitcher's plate. Along the same line, drive a stake at the 84-foot 10 1/4-inch marker. This will be the center of second base. Place the 120-foot marker at the center of second base and, taking hold of the cord at the 60-foot marker, walk to the right of the direction line until the cord is taut and drive a stake at the 60-foot marker. This will be the outside corner of first base and the cord will now form the lines to first and second bases. Again, holding the cord at the 60-foot marker, walk across the field and, in a like manner, mark the outside corner of third base. Home plate, first base, and third base are wholly inside the diamond. To check the diamond, place the home plate end of the cord at the first base stake and the 120-foot marker at third base. The 60-foot marker should now check at home plate and the middle of second base. In the layout of a 65-foot base path diamond, follow the same procedure with the following substitute dimensions: 65 feet, 130 feet, and 91 feet 11 inches. Check all distances with a steel tape whenever possible.

- A. The three-foot line is drawn in foul territory parallel to and three feet from the baseline, starting at a point halfway between home plate and first base.
- B. The batter's on-deck circle is a five-foot circle (2 1/2-foot radius) placed adjacent to the end of the player's bench or dugout area closest to home plate.
- C. There shall be batter's boxes, one on each side of home plate. The front line of the box will be drawn from the center of home plate. The inside lines of the batter's box shall be six inches from home plate, three feet wide and seven feet long.
- D. The catcher's box shall be as wide as the two batter's boxes from outside line to outside line, 8'5". The length of the catcher's box will be seven foot long.
- E. Each coach's box is behind a line 15 feet long drawn outside the diamond. The line is parallel to and eight feet from the first and third base line, extended from the bases toward home plate.
- F. The pitcher's plate shall be of rubber or wood, 24 inches long and six inches wide. The top of the plate shall be level with the ground. The front of the pitcher's plate shall be the prescribed pitching distances from the back point of home plate. It shall be permanently attached to the ground at distances indicated in Rule 2, Section 1. There shall be a 16-foot circle, eight feet in radius, drawn from the center of the pitcher's plate. The lines drawn around the pitcher's plate are considered inside the circle.
- G. Home plate shall be made of rubber or other suitable material. It shall be a five-sided figure, 17 inches wide across the edge facing the pitcher's plate. The sides shall be parallel to the inside lines of the batter's box and shall be 8 1/2 inches long. The sides of the point facing the catcher shall be 12 inches long.

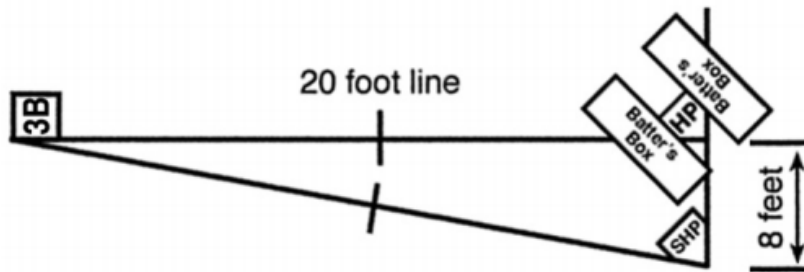

- H. The bases, other than home plate, shall be 15 inches square, be made of canvas or other suitable material and not more than five inches in thickness. The double base shall be used at first base, in all divisions of play. This base is 15 by 30 inches and both sides of the double base, white and contrasting color, shall be equal in height (5" max). Half the base is white (over fair territory), and half is of contrasting color (over foul territory). The bases should be properly fastened in position.
- I. The outfield fence height for Local Association, Regional, National Championships, National Championship Finals and the USA Softball Championships must be at least four feet high (at least three feet high if using temporary fencing) and it is suggested that it be eight feet in height.

- J. Local Association, Regional, and National Championship Final play; the minimum lighting guidelines can be found at www.USA Softball.com.

DIMENSION TABLE

<i>Area</i>	<i>Dimensions</i>
Backstop	25' minimum and 30' maximum from home plate.
Bases	15" square.
Base (Double)	15" X 30" of white/contrasting color.
a) Home Plate to first/third	60' from the back point of home plate to the back of the base.
Batter's Box	6" from home plate, 3 feet wide by 7 feet long; 4 feet in front of a line drawn through the center of home plate.
Catcher's Box	7' in length from rear outside corner of batter's box and 8' 5" wide.
Coaches Box	8' from the first and third base line, 15' long by 3' wide.
Home Plate	17" wide, sides parallel to the batter's box line and are 8 1/2" long, sides of the point facing the catcher are 12" long. The width of the black edge is 3/4".
On-Deck Circle	5' in diameter and 2' 6" radius.
Pitcher's Circle	8' radius drawn from the front edge of the pitcher's plate.
Pitcher's Plate	24" long and 6" wide.
Running Lane	Halfway line drawn in foul territory parallel to and 3' from the first base foul line. It starts halfway from home plate and goes to the back edge of first base.
Skinned Infield	Use front center of the 46' pitcher's plate as the center point of arc. 60' radius is recommended with 60' bases.

FIELD DIMENSIONS

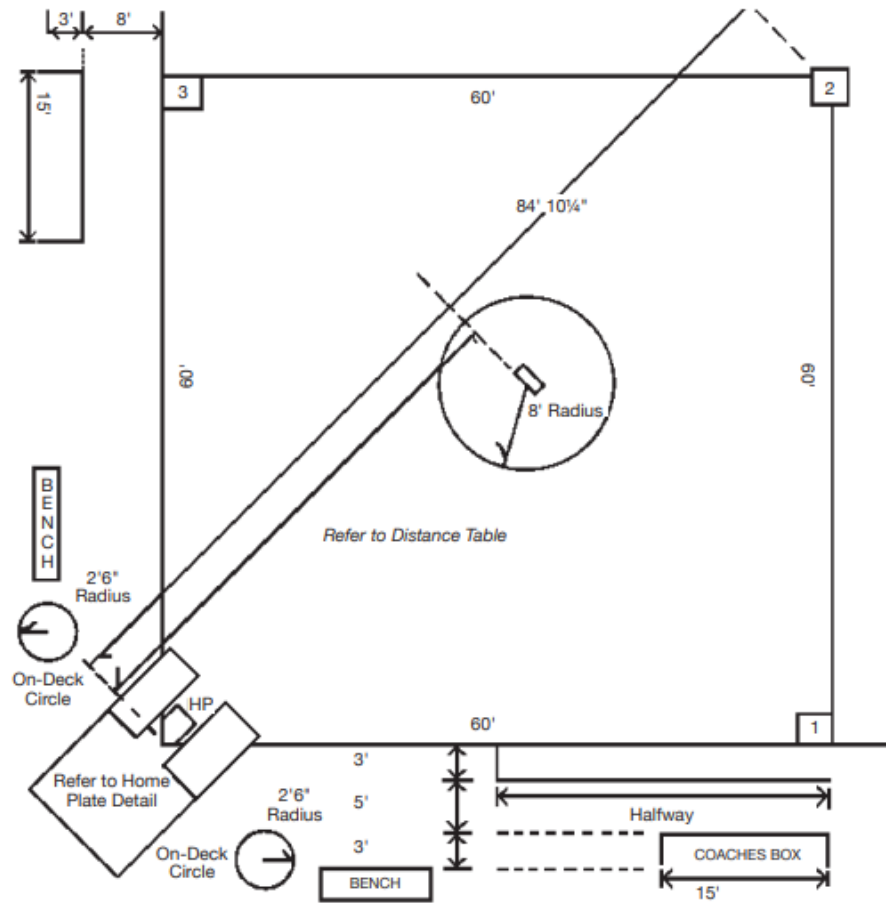

(For base distances, pitching distances and fence distances, see Rule 2, Section 1)

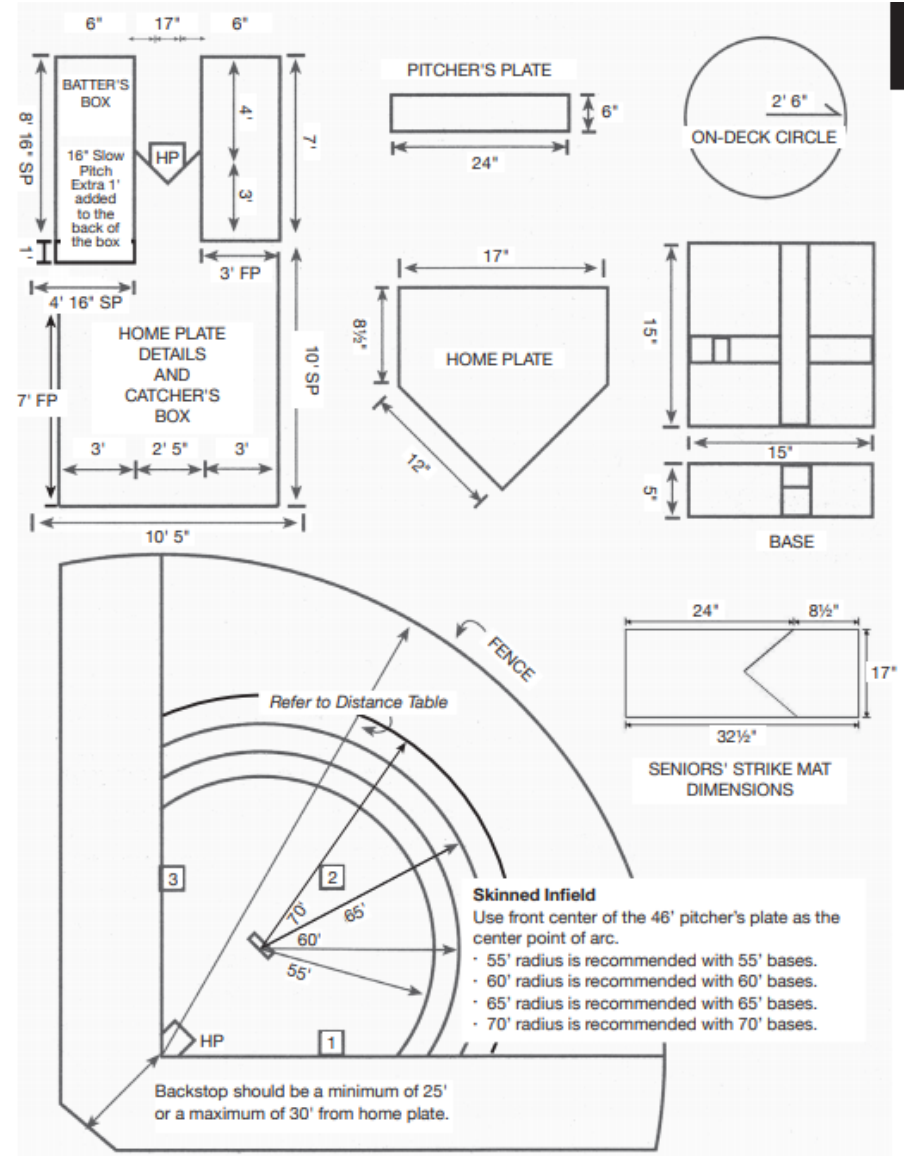
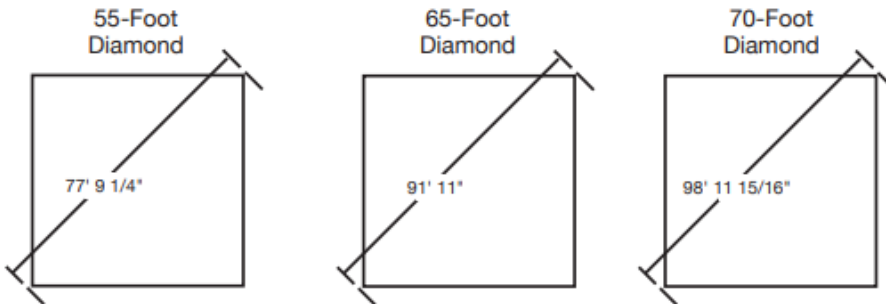

RULE 3 - EQUIPMENT

PREAMBLE TO RULE 3: Rule 3 governs the equipment to be used in USA Softball Championship Play. Equipment bearing USA Softball's approved certification mark(s) should not be construed as a warranty or guarantee that the equipment is safe or will safeguard

participants or spectators from injury. Instead, USA Softball's certification marks merely indicate that the equipment model has been tested and complies with USA Softball's rules for Championship Play. The primary purpose of Rule 3 and USA Softball's equipment standards is to promote competitive balance and to preserve the integrity of the sport of amateur softball. The use of USA Softball approved equipment in Championship Play or otherwise should not be considered a guarantee that participants, spectators, or others will be safe or free from injury or harm. There are risks and dangers incidental to the game of softball including specifically, but not limited to, the danger of being injured by thrown bats, thrown balls, batted balls, or other objects.

SECTION 1 - OFFICIAL BAT

- A. **CERTIFIED/APPROVED**: The official bat for USA Softball Championship Play must meet all the USA Softball specifications and the requirements of Rule 3, Section 1, and:
1. The official bat made up of the knob, handle, grip, taper, barrel, and end cap shall be free of burs, dents, cracks, sharp edges, rattles and show no signs of excessive wear. The official bat may be marked OFFICIAL SOFTBALL by the manufacturer and shall be no more than 34 inches long nor exceed 38 ounces in weight. The official bat shall not be more than 2.250 inches in diameter at its largest part, including any tolerance for expansion. The Official bat must bear the appropriate certification mark as shown below and must not be listed on the USA Softball Non-Approved Bat List with Certification Marks.
AND
 2. must be included on a list of approved bat models published by USA Softball
OR
 3. must, in the sole opinion and discretion of the umpire, have been manufactured prior to 2000 and if tested, would comply with the USA Softball Bat Performance Standard. This includes wooden bats.
Exception: Senior Softball bats may be used in Senior Championship Play only.
- B. **SAFETY KNOB**: The knob shall have a diameter of at least 1.6 inches with no sharp edges. The knob will be permanently attached to the bat and may be covered with grip tape.
- C. **HANDLE**: The region of the bat from the knob, not including the knob, to the start of the taper where the diameter increases. The handle will include a grip.
- D. **GRIP**: The Handle region of the bat must have a grip made of cork, grip tape, or other synthetic material that is permanently attached to the bat. No bare metal, wood or composite material may be exposed in this area. The grip shall not be less than 6" and not more than 15" from the knob. Resin, pine tar or spray substances are permissible on the grip region only.
- E. **TAPER**: The transition area between the handle and the barrel. The taper shall have a generally conical shape. It starts where the barrel decreases in size and ends where the handle diameter becomes constant.

- F. **BARREL**: The region of the bat from the taper to the end cap, not including the end cap. The barrel region shall be smooth and round within 0.050 inches in diameter.
- G. **END CAP**: The cap placed at the barrel end of the bat. The end cap shall be permanently affixed to the bat to prevent alterations to the interior of the bat. It shall be affixed so that it cannot be removed by anyone other than the manufacturer without damaging or destroying the end cap or barrel.
- H. **ALTERED BAT**: An USA Softball Official Bat's characteristic shall remain fixed at the time of manufacture and may not be altered in any way other than specifically provided for in Rule 3, Section 1 or as specifically approved by USA Softball. Approved bats shall be considered altered if they are rolled, shaved, repainted, weighted or modified to change their characteristics from that produced by the manufacturer. Identifying the bat by means of laser marking, engraving, or painting the name or number of the player will not make the bat an altered bat.
- I. **CONSTRUCTION**: The official bat shall be of one-piece construction, multi-piece permanently assembled or two-piece interchangeable construction. If the bat is designed with interchangeable components, it must meet the following additional criteria:
1. Mating components must have a unique locking key to prevent uncertified equipment combinations in the field.
 2. All component combinations must meet the one-piece bat rules.
 3. Manufacturer must demonstrate that the interchangeable bat fails in a safe manner (i.e., visible damage before locking feature(s) fail(s)).
 4. Bat components must be designed in a way to prevent uncertified equipment alterations.
Note: If the bat is not constructed of wood, and not made of one-piece construction with the barrel end closed, the barrel end shall have a rubber or vinyl plastic or other approved material insert, or end cap at the large end of the bat.

SECTION 2 - WARM-UP BAT

The warm-up bat shall meet the following requirements to be approved:

- A. Stamped with 1/4-inch letters WB on either end of the bat or marked in one-inch letters the words WARM-UP BAT only on the barrel end of the bat.
- B. The warm-up bat shall comply with the safety grip and the safety knob requirements of the official bat.
- C. Be of one-piece construction or a one-piece permanently assembled bat that clearly distinguishes itself as a warm-up bat and is approved by USA Softball.
- D. Shall have a safety knob of a minimum of 1/4 inch protruding at a 90-degree angle from the handle. It may be molded, lathed, welded, or permanently fastened.
- E. Only approved attachments included in the list published by USA Softball can be used on warm-up bats.

SECTION 3 - OFFICIAL SOFTBALL

A. **CERTIFIED/APPROVED:** Only softballs which bear an ASA or USA Softball approved certification mark signifying compliance with the Ball COR and Ball Compression limitations then in effect, and which satisfy all other applicable provisions in Rule 3, Section 3, will be allowed for use in USA Softball Play. USA Softball has developed two certification marks for softballs. One mark signifies Ball Compression 300 lbs. or less. The other signifies Ball Compression of more than 300 lbs., but less than 375 lbs. The ball must not appear on the USA Softball Non-Approved Ball List. The markings are also distinguishable by color, where green represents a Ball COR of .520 or under, red represents a Ball COR of .470 or under, black represents a Ball COR of .440 or under and blue represents a Ball COR of .400 or under. One of the following must be appropriately and indelibly stamped on each softball allowed for use in USA Softball Championship Play. The 12" Fast Pitch ball will have the following specifications: Size: 11 7/8 – 12 1/4, Weight: 6.50 oz – 7.00 oz., Compression: 275.0 LBS – 375.0 LBS, COR: .470 Max, and Dynamic Stiffness: 7500 LBS. Max.



Green Colored Marking & Stamp
Max 300.0 lbs
Max .520 cor



Black Colored Marking & Stamp
Max 300.0 lbs
Max .440 cor

Red Colored Marking & Stamp
Max 300.0 lbs
Max .470 cor

Blue Colored Marking & Stamp
Max 300.0 lbs
Max .400 cor



Red Colored Marking & Stamp
Max 375.0 lbs
Max .470 cor



Blue Colored Marking & Stamp
Max 375.0 lbs
Max .400 cor

Black Colored Marking & Stamp
Max 375.0 lbs
Max .440 cor

- B. **COVER:** The official softball shall have a cover of leather or synthetic material. The ball shall be regular, smooth-seamed, and smooth-surfaced.
- C. **THE 12-INCH BALL:** The official 12-inch softball shall be at least 12.0 inches in circumference when measured across two seams and shall weigh at least 6.750 ounces. The 12-inch ball shall have no fewer than 88 stitches in each cover, sewn by the two-needle method, or with an authentic facsimile of stitching as approved by USA Softball.
- Fast Pitch Ball:** The yellow optic cover, red-stitch 12-inch ball with a Ball COR of .470 or under and a Ball Compression of 375.0 lbs. or under shall be used in the following USA Softball play:
 - Women's and Women's Masters Fast Pitch, Girls 12, 14, 16 and 18-under Fast Pitch

- D. **THE 11-INCH BALL:** The official 11-inch softball shall be at least 11.0 inches in circumference. It shall weigh at least 6.0 ounces. The smooth-seamed style shall not have fewer than 80 stitches in each cover, sewn by the two-needle method, or with an authentic facsimile of stitching as approved by USA Softball.
- Fast Pitch Ball:** The white cover white stitch or optic yellow cover red stitch 11- inch ball (may be white-stitch for boy's fast pitch) with a ball core of .470 or under and a ball compression of 375.0 lbs. or under shall be used for the following USA Softball play:
 - Boys 10-under Fast Pitch
 - Girls 10-under Fast Pitch
- E. **THE 10-INCH BALL:** The official 10-inch softball shall be at least 10.0 inches in circumference when measured across two seams and shall weigh at least 5.50 ounces.

SOFTBALL	THREAD COLOR	COVER COLOR	SIZE	WEIGHT	MARKING
11" FP	White	White	At least 11.0"	At least 6.0 oz	ASA or USA Softball Logo
11" FP	Red	White/yellow	At least 11.0"	At least 6.0 oz	ASA or USA Softball Logo
12" FP	White	White	At least 12.0"	At least 6.75 oz	ASA or USA Softball Logo Red Marking
12" FP	White	White/yellow	At least 12.0"	At least 6.75 oz	ASA or USA Softball Logo Red Marking

SECTION 4 - GLOVE/MITT

A Glove/Mitt may be worn by any player. The dimensions of any glove/mitt used by any fielder shall not exceed the specifications set forth below (see drawing and specifications). (Fast Pitch) The Pitcher's glove may be of one solid color or multicolored if the color(s) are not the color of the ball being used in the game.

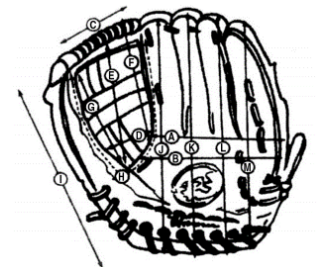

- Palm width (top) 8 in.
- Palm width (bottom) 8 1/2 in.
- Top opening of web 5 in.
- Bottom opening of web 4 1/2 in.
- Web top to bottom 7 1/4 in.
- 1st finger crotch seam 7 1/2 in.
- Thumb crotch seam 7 1/2 in.

- (h) Crotch seam 17 1/2 in.
- (i) Thumb top to bottom edge 9 1/4 in.
- (j) 1st finger top to bottom edge 14 in.
- (k) 2nd finger top to bottom edge 13 1/4 in.
- (l) 3rd finger top to bottom edge 12 1/4 in.
- (m) 4th finger top to bottom edge 11 in.

SECTION 5 - CATCHER'S EQUIPMENT, FACE MASK/GUARDS AND HELMET

- A. **CATCHER MASKS & EQUIPMENT**: Catchers must wear a mask with throat protector, approved helmet with ear flaps, shin guards which offer protection to the kneecaps and body protector. An extended wire protector may be worn in lieu of an attached throat protector. Any player warming up a Junior Olympic pitcher must wear a mask with throat protector and approved helmet with ear flaps. Catchers cannot merely wear the plastic face mask/guard.
- Note**: The ice hockey goalie style face mask is approved for use by catchers. If the throat protection built into the mask is inadequate, in the judgment of the umpire, a throat protector must be added to the mask before using.
- B. **FACE MASK/GUARDS**: Any defensive player or offensive player may wear a facemask/guard. Face masks/guards that are cracked or deformed, or if padding has deteriorated or is missing, are prohibited.
- Exception**: Fast pitch catchers cannot merely wear the plastic face mask/guard. Fast pitch catchers must wear the protective equipment provided by Rule 3 Section 5.
- Note**: A NOCSAE approved mask is only compatible with certain NOCSAE approved helmets. Failure to ensure proper compatibility may create unsafe conditions and may affect any manufacturer's product liability obligation. Contact the manufacturer or supplier of the helmet and the mask to ensure proper compatibility and approval of your specific mask-helmet combination.
- C. **HELMETS**: Any defensive player or offensive player may wear a helmet at any time. Helmets shall have a non-glare (not mirror-like) surface.
1. **Offense**: All Adult Fast Pitch, Modified Pitch, and all Junior Olympic offensive players, including the on-deck batter, and Junior Olympic players acting as coaches in the coach's box, must properly wear double ear flap NOCSAE approved batting helmets. All Junior Olympic batting helmets may be equipped with chin straps. All Junior Olympic Fast Pitch batting helmets shall be equipped with a securely fastened NOCSAE approved face mask/guard. Batting helmets that are broken, cracked, dented, or that have been illegally altered are prohibited from use.
- Note**: A NOCSAE approved mask is only compatible with certain NOCSAE approved helmets. Failure to ensure proper compatibility may create unsafe conditions and may affect any manufacturer's product liability obligation. Contact the manufacturer or supplier of the helmet and the mask to ensure proper compatibility and approval of your specific mask-helmet combination.
- Effect**: Failure to wear the batting helmet when ordered to do so by the umpire

shall cause the player to be removed from the game. Wearing the helmet improperly or removing the helmet during a live ball play and judged by the umpire to be a deliberate act shall cause the violator to be declared out immediately. The ball remains live. Calling a runner out for removing a helmet does not remove force play situations. Umpires should use discretion as to the intent of the rule concerning player safety.

2. **Defense**: Any defensive player may wear a helmet, with or without ear flaps, of similar color as the team caps. It must have a bill.

Exception: Hockey Style Face Mask.

- D. **PROTECTIVE EQUIPMENT**: Unless more stringent equipment is required by these rules any offensive or defensive player may wear any protective equipment. As specifically set forth in these rules, helmets may be required to be worn in certain situations during certain play, however, regardless of whether helmets are mandated by rule, any player shall have a right to wear a helmet at any time and during any part of the game, if that player so desires. Helmets shall have a bill.

WARNING: The game of softball involves certain risk, including but not limited to death, serious neck and spinal injuries resulting in complete or partial paralysis, brain damage and serious injury to virtually all bones, joints, muscles, and internal organs. Equipment used may be inadequate to prevent serious injury. However, in certain situations, the player's use of a helmet may prevent or lessen certain injuries. Players choosing to not wear helmets do so with knowledge of the danger involved and agree to accept all liability for any injury or property loss related in any way to a player's decision not to wear a helmet.

- E. **HELMETS**: Any defensive player or offensive player may wear a helmet at any time. (Fast Pitch Only) Helmets shall have a non-glare (not mirror-like) surface.

1. **Offense**: All Adult Fast Pitch, Modified Pitch, and all Junior Olympic offensive players, including the on-deck batter, and Junior Olympic players acting as coaches in the coach's box, must properly wear double ear flap NOCSAE approved batting helmets. All Junior Olympic batting helmets may be equipped with chin straps. All Junior Olympic Fast Pitch batting helmets shall be equipped with a securely fastened NOCSAE approved face mask/guard. Batting helmets that are broken, cracked, dented, or that have been illegally altered are prohibited from use.

Note: A NOCSAE approved mask is only compatible with certain NOCSAE approved helmets. Failure to ensure proper compatibility may create unsafe conditions and may affect any manufacturer's product liability obligation. Contact the manufacturer or supplier of the helmet and the mask to ensure proper compatibility and approval of your specific mask-helmet combination.

Effect: Failure to wear the batting helmet when ordered to do so by the umpire shall cause the player to be removed from the game. Wearing the helmet improperly or removing the helmet during a live ball play and judged by the umpire to be a deliberate act shall cause the violator to be declared out immediately. The ball remains live. Calling a runner out for removing a helmet does not remove force

play situations. Umpires should use discretion as to the intent of the rule concerning player safety.

2. Defense: Any defensive player may wear a helmet, with or without ear flaps, of similar color as the team caps. It must have a bill.

Exception: Hockey Style Face Mask.

- F. **PROTECTIVE EQUIPMENT:** Unless more stringent equipment is required by these rules any offensive or defensive player may wear any protective equipment. As specifically set forth in these rules, helmets may be required to be worn in certain situations during certain play, however, regardless of whether helmets are mandated by rule, any player shall have a right to wear a helmet at any time and during any part of the game, if that player so desires. Helmets shall have a bill. **WARNING:** The game of softball involves certain risk, including but not limited to death, serious neck and spinal injuries resulting in complete or partial paralysis, brain damage and serious injury to virtually all bones, joints, muscles, and internal organs. Equipment used may be inadequate to prevent serious injury. However, in certain situations, the player's use of a helmet may prevent or lessen certain injuries. Players choosing to not wear helmets do so with knowledge of the danger involved and agree to accept all liability for any injury or property loss related in any way to a player's decision not to wear a helmet.

SECTION 6 - UNIFORM

All players on a team shall properly wear uniforms that are like in color and style. Sleeves or straps of the uniform top may be adjusted, with or without tie-ups, to the comfort of the players, provided uniform numbers remain visible. If because of the blood rule a change is required and the uniform part does not match, the player will not be penalized. All protective equipment should be worn properly. If a player is requested by the umpire to remove jewelry, illegal shoes or illegal parts of the uniform and they refuse, the player will not be allowed to play.

A. **HEADWEAR:**

1. Ball caps, visors, and head/sweat bands, both pullover and tied, are optional for players. If worn, they may be mixed and must be worn properly. Colors to include black, white, gray, beige, pink or team colors. The colors may be mixed and are not required to be the same for all team members. Handkerchiefs do not qualify as headwear and cannot be worn around the head or neck. Plastic visors are not allowed.

- B. **PANTS/SLIDING PANTS:** All players' pants may be long, short, or mixed in style, if they are like in color. Players may wear a solid-colored pair of sliding pants. It is not mandatory that all players wear sliding pants, but if more than one player wears them, they must be like in color and style. No player may wear ragged, frayed, or slit legs on exposed sliding pants.

- C. **UNDERSHIRTS:** Players may wear a solid-colored undershirt. It is not mandatory that all players wear an undershirt, but if more than one player wears one, they must be like in

color and style. No player may wear ragged, frayed, or slit sleeves on exposed undershirts.

- D. **NUMBERS:** An Arabic whole number (0-99) of contrasting color, or outlined in contrasting color, at least three inches high must be clearly visible on all uniform shirts. 00 and 0, 01 and 1 are examples of different numbers. No players on the same team may wear identical numbers. Players without numbers will not be permitted to play. There is no penalty for a player wearing a wrong number or a duplicate number. Correct the number in the score book or have the player(s) change jerseys in case of duplication and continue play.
- E. **CASTS/PROSTHESIS:** All casts and splints must be padded. Prosthesis may be worn. Braces with exposed hard surfaces must be padded. Any of this equipment judged by the umpire to be potentially dangerous is illegal. Any decision by the umpire should be based on whether a device worn or used by an individual with a disability changes the fundamental nature of the game or poses a significant risk to the welfare of other players.
- F. **JEWELRY:** Exposed jewelry, which is judged by the umpire to be dangerous, must be removed and may not be worn during the game. Medical alert bracelets or necklaces are not considered jewelry. If worn, they must be taped to the body, so the medical alert information remains visible.
- G. **SHOES:** Must be worn by all participants. A shoe shall be considered official if it is made with either canvas or leather uppers or similar material(s). The soles may be either smooth or have soft or hard rubber cleats. Ordinary metal sole or heel plates may be used if the cleats on the plates do not extend more than 3/4 of an inch from the sole or heel of the shoe. Shoes with round metal spikes are illegal. Shoes with detachable cleats that screw on are not permitted; however, shoes with detachable cleats that screw INTO the shoe are permitted.

Exception: *Junior Olympic Fast Pitch 10U, 12U Play: No metal cleats. No metal spikes nor hard plastic or polyurethane spikes like metal sole and heel plates are allowed.*

Effect: Players wearing metal cleats after being warned by the umpire, shall be ejected.

SECTION 7 - ALL EQUIPMENT

- A. Notwithstanding the foregoing, USA Softball reserves the right to withhold or withdraw approval of any equipment which, in USA Softball's sole determination, significantly changes the character of the game, affects the safety of participants or spectators, or renders a player's performance more a product of the player's equipment rather than the player's individual skill.
- Note:** The characteristics of any approved equipment cannot be unnaturally changed. Examples include icing, cooling, or heating of any equipment. In addition, approved bats shall not be rolled, shaved, or modified to change their characteristics from that produced by the manufacturer. Warming devices for bats are not approved.
- B. The National Championship UIC, Assistant UIC or Staff has the right to remove all equipment not meeting Rule 3 including bats and helmets, through pregame inspection,

bat testing or during a game. Removed equipment will be marked properly with the name of the team and/or player and will be returned after the team's final game of the Championship. The equipment will be securely stored by the Championship Committee until returned to the team and/or player.

- C. For pregame inspection, all equipment shall be inspected by the umpire, and is to be placed outside the dugout/team area prior to the start of the game.

RULE 4 – PLAYERS, COACHES, SUBSTITUTES

SECTION 1 - PLAYERS

- A. A team must have the required number of players present in the dugout or team area to start or continue a game.
- Line-up cards are to be completed and submitted to the official scorer and umpire at the start of each game. A starting player shall be official when the line-up is inspected and approved by the plate umpire and team manager at the pre-game meeting. The line-up shall contain the first and last name, defensive position, and uniform number of each player. If a wrong number is on the line-up, correct it and continue playing with no penalty. All available substitutes should be listed in the designated place by their last name, first name and uniform number.
 - Eligible roster members may be added to the available substitute list at any time during the game.
- B. Male rosters shall include only male players and female rosters shall include only female players.
- C. A team shall consist of players in the following positions:
- Fast Pitch:**
 - Fast Pitch with Nine players: Pitcher (F1), catcher (F2), first base (F3), second base (F4), third base (F5), shortstop (F6), left fielder (F7), center fielder (F8) and right fielder (F9).
 - Fast Pitch with Designated Player (DP) and Flex: 10 Players with nine batting
 - Fast Pitch Junior Olympic Pool Play Only: When batting up to all roster players, any additional batter(s) shall be listed as an EP and may be listed anywhere in the batting order and may play defense at any position.
 - Allows for one EP so you can bat 10.
 - Allows you to use the DP/Flex with one EP to bat 10 players.

Effect: In both D and E, any player in the line-up can play defense. Substitutions for the pitcher and catcher must be reported.

If discovered using the wrong number of females or males in the outfield or infield and brought to the umpire's attention by the offended team:

- After a pitch legal or illegal or play made,
Effect: All action stands.
- Before the next pitch legal or illegal or play made,

- Before the defense has left the field,
- Before the umpires have left the field of play,

Effect: 2,3 and 4.

- If the batter hits the ball and reaches first base safely, and all other runners have advanced at least one base. All action of the batted ball stands.
- If all runners, including the batter-runner, do not advance at least one base, the manager has the option of taking the result of the play, or award the batter first base and advances all runners, if forced.

- D. Shorthanded Rule:

- To start a game:
 - A game may begin or finish with one less than required to start.
 - The vacant position must be listed last in the batting order.
 - An out will be recorded when the vacant position in the batting order is scheduled to bat.
Effect: Failure to have the required number of eligible players to start or continue a game will result in a forfeit.
- To continue a game once started with a full team listed on the line-up card:
 - If a team begins play with the required number of players as listed, that team may continue a game with one less player than is currently in the batting order whenever a player leaves the game for any reason other than ejection. Under no circumstances shall a team be permitted to bat less than 8 in Fast Pitch.
Exception: When a team elects to use more than nine batters an out will be recorded if a player leaves the game for any reason other than injury or ejection. If a player leaves for an injury and cannot continue in the game, the game will continue with the injured player(s) batting position(s) being skipped without an out being recorded. Teams cannot play with fewer than eight players.
 - If playing shorthanded and a substitute arrives the substitute must be inserted immediately into the vacant spot. If the substitute refuses to enter for any reason that player becomes ineligible for the remainder of the game.
 - If the player leaving the game is a runner or batter, the runner or batter shall be declared out.
 - When the player who has left the game is scheduled to bat, an out shall be declared for each turn at bat. An inning or the game can end with an automatic out.
 - The player who has left the game cannot return to the line-up.
Exception: A player who has left the game under the blood rule may return even after missing a turn at bat.

SECTION 2 - AMERICAN DISABILITY ACT RULE

These Rules shall be subject to requests for reasonable modification for purposes of complying with the Americans with Disabilities Act (ADA) unless such modifications would change the fundamental nature of the activity or would pose a significant risk to the safety of other participants. A person who, because of a disability, would like a reasonable modification to the Rules to participate should advise the applicable Local Association Member, league, tournament director, and/or event organizer of the requested modification, why it is needed, and how the modification would avoid disability discrimination, including how the modification will address the player's specific disability. Such modification requests should be made sufficiently in advance so that an individualized inquiry may be undertaken to decide whether to allow the requested modification. Such an inquiry will include consideration of the participant's specific circumstances and the purpose of the rule, policy, or practice at issue. It is highly recommended that participants provide notice of such requests to the applicable Local Association Member, league, tournament director, and/or event organizer sufficiently in advance of and prior to or during the league or tournament.

- A. This rule may be used for a player that has been determined by the American Disabilities Act of July 25, 1990, to be physically challenged. As a result of the player's disability, the player can play either offense or defense.
- B. In appropriate circumstances, the following Rules may be used in the event a person is determined to be an ADA Player. For these ADA Flex Player, EP and DP rules to apply, the ADA player's specific disability shall correspond to the need for the application of these Flex Player, EP and DP rules.
- C. Teams using a physically challenged player on offense or defense must have 11 players. If the physically challenged player can play both, 10 players are needed.
- D. When a physically challenged person plays offense only, the team will follow the EP rule as written. There would be 11 hitters including the ADA player, and only 10 who play defense.
- E. When a physically challenged player plays defense only, they will be listed as the FLEX and placed last in the line-up. The team has the option to bat 10 or 11 players (if the EP is also used). When using a FLEX, it must be made known prior to the start of the game.
- F. If a team starts the game with the FLEX option, the FLEX player can never play offense. If this person for any reason cannot continue to play and the team has no other physically challenged player for a substitute, the EP can now play defense.
- G. The FLEX position has the same re-entry status as any other starting position if the person substituted is also determined to be physically challenged under the ADA program. The original FLEX player may re-enter only in the same spot in the batting order.
- H. The DP/FLEX rule in fast pitch accommodates the ADA rule.
- I. Any eligible player on the official line-up, including available substitutes, may be used as a courtesy runner for an ADA player. Unlimited courtesy runners are allowed each inning.
- J. A participant who is hearing-impaired may use a sign language interpreter or other auxiliary hearing aid during play to assist that hearing-impaired participant. A sign language interpreter shall be allowed in the dugout, on the field of play (fair or foul territory), or in other areas to be able to provide communication to the hearing-impaired participant, but such sign language interpreter shall be subject to any other rules, policies, or practices generally applicable to participants, including submitting to and passing an annual background check screening, if applicable. Any concerns, issues or requests concerning the specific location of such interpreters on the field of play shall be resolved by the umpire(s) during gameplay and such concerns or requests shall be addressed to and resolved by the applicable Local Association Member, league, tournament director, and/or event organizer in advance of gameplay. It is highly recommended that participants provide notice of such requests to the applicable Local Association Member, league, tournament director, and/or event organizer sufficiently in advance of and prior to or during the league or tournament registration process prior to the start of a season or tournament.
- K. Creates an additional section in the ADA Rule which allows a player with a disability, who needs to come out of the game due to the disability, to have a replacement player until the disability subsides.

SECTION 3 - DESIGNATED PLAYER (Fast Pitch)

- A. A designated player (DP) may be used for any player provided it is made known prior to the start of the game and the player's name is indicated in the line-up as one of the nine in the batting order (or any position in the batting order for Junior Olympic Fast Pitch Pool Play).
- B. The name of the player for whom the DP is batting (FLEX) will be placed in the 10th position or the last position in the line-up.
- C. The starting player listed as the DP must remain in the same position in the batting order for the entire game. The DP and the DP's substitute, or the substitute's replacement, may never play offense at the same time.
- D. The DP may be substituted for at any time by a pinch-hitter, pinch-runner, or the FLEX. If the starting DP is replaced on offense by the FLEX the DP will leave the game. If replaced by a substitute the DP position remains in the line-up. A starting DP may re-enter one time if the DP returns to the original position in the batting order.
 - 1. If replaced by the FLEX the number of players are reduced from 10 to nine. If the DP does not re-enter, the game may legally end with nine players.
 - 2. If the DP re-enters and the FLEX was batting in the DP's position, the FLEX can return to the 10th position and play defense only or leave the game.
- E. The DP may play any defensive position. Should the DP play defense for a player other than the one for whom the DP is batting (FLEX), that player will continue to bat but not

play defense and is not considered to have left the game. If the DP plays defense for the FLEX, the FLEX is considered to have left the game, the number of players is reduced from 10 to nine. The FLEX can re-enter the game.

- F. The person being batted for (FLEX) may be substituted for at any time, by a legal substitute or the DP for whom the FLEX is playing defense. The FLEX may re-enter the game one time, in the 10th position or in the DP's position in the batting order.
- G. If returning to the 10th position, the FLEX will again play defense only but may play any defensive position.
- H. If the FLEX returns to the DP's position the FLEX will play offense and defense; there will be only nine players in the batting order.
- I. Placing the defensive only player (FLEX) into one of the first nine positions for someone other than the DP is considered an illegal player. The illegal player shall be disqualified. Rule 4, Section 6F [2]. The FLEX replacing the DP is not considered a substitution for the FLEX. The DP, who has left the game, can re-enter the game.

SECTION 4 - EXTRA PLAYER

- A. An extra player is optional, but if used, it must be made known prior to the start of the game and be listed on the line-up card in the regular batting order. If the extra player is used, the extra player must be used the entire game. If an extra player is used and not listed on the line-up card, the following occurs:

Effect:

1. If discovered while the non-listed extra player is at bat, the legal batter enters the game and assumes count, or
 2. If discovered while the non-listed extra player is on base and before a pitch legal or illegal has been thrown to the next batter, treat as batting out of order. The player who should have batted is out. Any advancement or score of a runner because of the non-listed EP is negated. The person not listed in line-up is disqualified from the game, or
 3. If discovered while the non-listed extra player is on base and a pitch has been thrown to the next batter, remove the non-listed extra player from the base, or if the player has scored, nullify the run, and disqualify the player from the game.
- B. The extra player must remain in the same position in the batting order for the entire game.
 - C. The extra player may be substituted for at any time. The substitute must be a player who has not yet been in the game. The starting extra player may re-enter.
 - D. All batters listed in addition to the nine defensive players and DP if used. They can be listed anywhere in the batting order.

SECTION 5 - RE-ENTRY

Any player may be substituted for or replaced and re-entered once, provided the players occupy their same batting position in the batting order.

- A. The starting player and their substitute may not be in the line-up at the same time.

- B. If a player re-enters the game a second time or a player re-enters the game in a position in the batting order other than their original starting or substitute position, this is considered an illegal re-entry.

Effect - Section 5A-C: Violation of the re-entry rule is considered an illegal player. The illegal player shall be disqualified. Rule 4, Section 6F [4].

SECTION 6 - SUBSTITUTES/ILLEGAL PLAYER

A substitute may take the place of a player whose name is in their team's batting order. The following regulations govern player substitutions:

- A. The manager or team representative of the team making the substitution shall notify the plate umpire at the time the substitute enters. The plate umpire shall then report the change to the scorer. (Fast Pitch) Any defensive change involving the pitcher or catcher must be reported to the umpire.
- B. A substitute shall be considered officially in the game when reported to the plate umpire. The player does not violate the unreported substitute rule until a pitch, legal or illegal, or a play has been made. The use of an unreported substitute is handled as a protest by the offended team while the player is in the game.
Effect: Upon being properly protested, the player will now be officially in the game, and subject to penalties as appropriate and listed in Rule 4, Section 6C [1-9].
- C. A substitute who enters the game without reporting is considered an unreported substitute:
 1. After a pitch, legal or illegal, or a play made.
Effect: Player is officially in the game and all action stands.
 2. When an unreported substitute is discovered while at bat.
Effect: The unreported substitute is officially in the game and assumes the ball and strike count and all action stands.
 3. When discovered after completing their turn at bat and:
 - a. BEFORE the next pitch, legal or illegal.
 - b. BEFORE the defense has left the field of play.
 - c. BEFORE the umpires have left the field of play.
Effect:
 1. The unreported substitute is officially in the game and called out.
 2. All other outs that occur on this play stand.
 3. All other runners will return to the base occupied at the time of the pitch.
 4. When discovered after completing their turn at bat and:
 - a. AFTER the next pitch, legal or illegal.
 - b. BEFORE the defense has left the field.
 - c. BEFORE the umpires have left the field of play.
Effect:
 1. The unreported substitute is officially in the game.
 2. Any advance of a runner because of the play is legal.

5. When a runner and that runner is brought to the attention of the umpire BEFORE a pitch, legal or illegal, or a play made.
Effect: No penalty. Replace the unreported substitute with the correct player or enter them as a legal substitute.
6. When a runner and that runner is protested AFTER a pitch, legal or illegal, or a play made.
Effect: The runner is officially in the game. Any advance of the runners is legal.
7. When on defense is protested by the offense BEFORE a pitch, legal or illegal.
Effect: No penalty. Replace with the correct player or enter them as a legal substitute.
8. When on defense MAKES A PLAY and is protested:
 - a. BEFORE the next pitch, legal or illegal.
 - b. BEFORE the defense has left the field.
 - c. BEFORE the umpires have left the field of play.
Effect: The unreported substitute is officially in the game and the offensive team has the option to:
 1. Take the result of the play or
 2. Have the last batter return to bat and assume the ball and strike count and
 3. All runners return to the last base occupied prior to the play.
9. When on defense is protested AFTER a pitch, legal or illegal, to the next batter.
Effect: The unreported substitute is officially in the game and all play stands.
Note: If the substitute is an illegal player for any reason, the substitute will be subject to the penalty for that violation.
- D. If an injury to a batter-runner or runner prevents them from proceeding to an awarded base, and the ball is dead, a substitute for the batter-runner or runner may be made. The substitute will be allowed to proceed to any awarded base(s). The substitute must legally touch any awarded or missed base(s) not previously touched. This is not a courtesy runner, but a legal substitute.
Exception: Junior Olympic Fast Pitch Pool Play only, any player may replace the injured player.
- E. A player will not violate the illegal player rule until a pitch, legal or illegal, or a play is made. The use of an illegal player is handled as a protest by the offended team while the player is in the game.
Effect: Once the umpire has been informed, the illegal player shall be disqualified and can be legally replaced either by a substitute or a starter who re-enters the game.
- F. Illegal Players Include:
 1. **Illegal Pitcher.** A player who returns to pitch after being removed from the pitching position by the umpire,
Effect: Once discovered, the illegal pitcher shall be disqualified and all play stands.
 2. **Illegal Batter.** Placing the "FLEX" player in one of the first nine positions in the batting order for someone other than the DP.

3. **Illegal Runner.** Occurs when:
 - a. An offensive player is placed in the line-up as a runner for another offensive player.
 - b. (Fast Pitch) The FLEX is placed in the line-up as a runner for someone other than the DP.
 - c. A player does not report as a courtesy runner, or an illegal courtesy runner is used.
4. **Illegal Re-Entry.** Occurs when:
 - a. A starting player returns to the game a second time after being substituted for twice.
 - b. A starting player returns to the game but is not in their original position in the batting order.
 - c. A substitute returns to the game a second time after being replaced twice.
Effect - Rule 4, Section 6F [2-4]: The Illegal Player is disqualified and replaced with a legal substitute. All other provisions of Rule 4, Section 6A-C [1-9] apply.

SECTION 7 - COACH

- A. A coach is responsible for the team's actions on the field and will represent the team in communications with the umpire and opposing team. A player may be designated as a coach in the event the coach is absent or that player is acting as a player/coach.
- B. Coaches must be neatly attired or dressed in the team uniform. If a coach wears a hat/cap, it must be approved head wear.
Effect: The coach(s) cannot be on the playing field to coach their team.
- C. A base coach is an eligible team member or coach of the team at bat who occupies the coach's box at first or third, to direct the offensive players.
 1. When in the coach's box a base coach may have a scorebook (electronic or paper), pen, pencil, electronic marker, or an exclusively one-way communication device to relay signals to the offense.
 2. A base coach shall stay within the confines of these boxes with both feet.
 - a. A coach may leave the coach's box to signal the runner to slide, advance or return to a base or move out of a fielder's way if the coach does not intentionally interfere with the play.
 - b. A coach may not leave the coach's box to give verbal communications or signals to the batter.
Effect: After a warning, an offensive conference will be charged.
 3. Base coaches may not use language that will reflect negatively upon players, umpires, or spectators.
 4. A base coach may address only their team members.
 5. An exclusively one-way electronic communication device may be used by the defense to relay the pitch or play call from the dugout.
Effect: If a two-way communication device is used, disqualification or ejection from the game occurs after a warning.

SECTION 8 - DISQUALIFIED OR EJECTED PARTICIPANT

- A. A disqualified player is prohibited from playing but can remain in the team area or serve as a coach/manager.
Effect: If found playing, the game is forfeited.
- B. An ejected participant must leave the grounds and have no contact with the umpires or participants in the game and is suspended for one additional game. The ejected participant is restricted from having contact with the team and is not permitted to sit in the stands, dugout, or general locality of the next game. The ejected participant may appeal the one game suspension to the Championship Protest Committee.
Effect: The game is forfeited.
- C. Any arguing on the judgment of balls and strikes will result in a team warning.
Effect: Any repeat offense shall result in the ejection of that team member.
- D. If a player is disqualified a team can play shorthanded, however if a player is ejected and the team does not have enough players, play cannot continue.
Effect: The game is forfeited.

SECTION 9 - BLOOD RULE

A game participant or umpire who is bleeding or who has blood on their uniform shall be prohibited from participating further in the game until appropriate treatment can be administered. If medical care or treatment is administered in a reasonable length of time, the individual will not have to leave the game. The length of time that is considered reasonable is left to the umpire's judgment. Uniform rule violations will not be enforced if a uniform change is required. The umpire shall:

- A. Stop the game and immediately, call a coach, trainer or other authorized person to the injured player and allow treatment.
- B. Apply the rules of the game regarding substitution, short-handed rule, and re-entry if necessary.

SECTION 10 - INJURED PLAYER

During a live ball situation, when a player becomes injured, and in the umpire's, judgment requires immediate attention, the umpire shall call "DEAD BALL".

Effect: Award any bases that would have been reached.

RULE 5 - THE GAME

SECTION 1 - HOME TEAM

Prior to the start of all games, the home team shall be decided by a coin toss.

Exception: In the championship game only, the undefeated team shall decide the home team. If there is more than one undefeated team or in the event of an "IF" game, the home team shall be decided by a coin toss.

SECTION 2 - FITNESS OF THE GROUNDS

The fitness of the grounds for a game shall be decided solely by the plate umpire.

SECTION 3 - REGULATION GAME

- A. A regulation game shall consist of seven innings. A full seven innings need not be played if the team second at bat scores more runs in six and one-half innings and/ or before the third out in the last of the seventh inning, the run-ahead rule is applied or after the time limit has expired.
- B. A game that is tied at the end of seven innings, or after time limit has expired shall be continued by playing additional innings until one side has scored more runs than the other at the end of a complete inning, or until the team second at bat has scored more runs in their half of the inning before the third out is made.
- C. A game called by the umpire shall be regulation if five or more complete innings have been played, or if the team second at bat has scored more runs in four or more innings than the other team has scored in five or more innings. The umpire is empowered to call a game at any time because of darkness, rain, fire, panic, or any other cause that places the patrons or players in peril.
- D. Games that are not considered regulation shall be resumed at the exact point where they were stopped.
- E. A regulation tie game shall be declared if the score is equal when the game is called at the end of five or more complete innings, or if the team second at bat has equaled the score of the first team at bat in the incomplete inning.
- F. Games that are regulation tie games shall be resumed at the exact point where they were stopped.

SECTION 4 - FORFEITED GAMES

A forfeited game shall be declared by the umpire in favor of the team not at fault in the following cases:

- A. If an umpire is physically attacked by any team member and/or spectator.
- B. If a team fails to appear on the field, or being on the field, refuses to begin a game for which it is scheduled or assigned within a time set for forfeitures by the organization that the team represents.
- C. If one side refuses to continue to play after the game has begun unless the game has been suspended or terminated by the umpire.
- D. If, after play has been suspended by the umpire, one side fails to resume playing within two minutes after "play ball" has been declared by the umpire.
- E. If a team employs tactics noticeably designed to delay or to hasten the game.
- F. If, after a warning by the umpire, any rules of the game are willfully violated.
- G. If the order for the ejection of a game participant is not obeyed within one minute.
- H. If the ejection of a player or players from the game results in fewer than the required number of players to continue the game.
- I. If an ejected participant is discovered participating or has contact with the umpires or other participants in the game.
- J. If a team is playing one player short and another player becomes injured or ill leaving the team with two less players than the required number.

- K. Once a game has been forfeited the forfeit cannot be changed.

SECTION 5 - SCORING OF RUNS

- A. One run shall be scored each time a runner:
1. Touches first, second, third base and home plate.
 2. When using the tie breaker rule, a runner starting at second base, touches third base and home plate.
- B. No run shall be scored if the third out of the inning is the result of:
1. A batter-runner being called out prior to reaching first base or any other runner forced out due to the batter becoming a batter-runner. On an appeal play, the force out is determined when the appeal is made, not when the infraction occurred. Therefore, if the batter-runner or trail runner is put out prior to an appeal, the out on the appeal will not be considered a force out.
 2. A runner being put out by a tag, called out for passing a runner or a live ball appeal prior to the lead runner touching home plate.
 3. The preceding runner is declared out on an appeal play.
- C. No run shall be scored if a "fourth out" is the result of an appeal of a base missed or left too soon on a runner who has scored.

SECTION 6 - GAME WINNER

The winner of the game shall be the team that scores more runs in a regulation game.

- A. The score of a called regulation game shall be the score at the end of the last complete inning, unless the team second at bat has scored an equal number or more runs than the first team at bat in the incomplete inning. In this case the score shall be that of the incomplete inning.
- B. The score of a regulation tie game shall be the tie score when the game was terminated.
- C. The score of a forfeited game shall be seven to zero in favor of the team not at fault.

SECTION 7 - CONFERENCES

- A. Offensive Conference: There shall be only one charged conference between team representatives and the batter, another team representative, and/or runners in an inning. The umpire shall not permit any such conferences more than one in an inning.
Effect: Ejection of the manager or team representative who insists on another charged conference.
- B. Defensive Conference: There shall be only three charged conferences between the manager or other team representative from the dugout with any defensive players in a seven-inning game. For every inning beyond seven, there shall be one charged conference per inning between the manager or other team representative from the dugout with any defensive players.
Effect: The fourth and each additional, charged conference in a seven-inning game, or for any charged conference more than one per inning in an extra inning game, shall result in the removal of the pitcher from the pitching position for the remainder of the

game. The removed pitcher can play another position on defense but cannot pitch again.

SECTION 8 - RUN AHEAD RULE

- A. A run ahead rule must be used at all National Tournaments.
1. Fast Pitch:
 - a. 15 after three innings, 12 after four innings or eight after five innings
 - B. Complete innings must be played unless the home team scores the run ahead limit while at bat. When the visiting team reaches the limit in the top half of the inning, the home team must have their opportunity to bat in the bottom half of the inning.

SECTION 9 - TIME LIMIT WITH ADDITIONAL INNING RULE

When the time limit rule is in effect time begins with the first warm up pitch. If the game is tied after the time limit has expired, the tie breaker rule shall be in effect at the start of the next inning and play shall continue until a winner is determined. The time limit rule is as follows:

- A. In Junior Olympic Fast Pitch 10-Under Class A and 10-Under Class B pool and elimination play, the time limit is one hour and forty minutes and finish the inning. If the game is still tied after the time limit has expired, the tie-breaker rule shall be in effect at the start of the next inning.
Exception: The Championship and "IF" game of the 10U USA Softball National Championship will have a two-hour time limit (reference Procedural Code).
- B. In Junior Olympic Fast Pitch Class A and Class B 12-under, 14-under, 16-under, 18-under pool and elimination play, the time limit is one hour and forty minutes and finish the inning. If the game is still tied after the time limit has expired, the tie-breaker rule shall be in effect at the start of the next inning.
Exception: There shall be no time limit on elimination play beginning with the winner's bracket final.
- C. In Junior Olympic Fast Pitch 16U Gold and 18U Gold Pool Play Only, the time limit is one hour and forty minutes and finish the inning. If the game is still tied after the time limit has expired, the tie-breaker rule shall be in effect at the start of the next inning. There is no time limit in elimination play.

SECTION 10 - TIE-BREAKER RULE

When after the completion of seven innings of play or time has expired, the score is tied, the following Tiebreaker rule will be played to determine a winning team.

- A. Starting with the top of the eighth inning, and each half inning thereafter, the offensive team shall begin its turn at bat with the player who is scheduled to bat last in that respective half inning being placed on second base (e.g., if the number five batter is the leadoff batter, the number four batter in the batting order will be placed on second base. A substitute may be inserted for the runner).

- B. If a team is in the tiebreaker and the Short-Handed Rule is in effect, do not declare an out if the absent player is the one who should begin the half inning at second base. Instead, place on second base the player whose name precedes the absent player's name in the line-up.

SECTION 11 - DUGOUT AND ON FIELD CONDUCT

- A. Coaches, players, substitutes, and other bench personnel shall not be outside the designated bench, dugout/team area except when the rule allows or is justified by the umpire.
- B. The use of alcoholic beverages or tobacco products is prohibited at all Junior Olympic Championships.
Effect-Section 12A-C: The first offense is a team warning. Any repeat offense shall result in the ejection of that team member.
- C. No person may knowingly possess or have under his/her control a weapon or explosive device on the playing field or in the dugout. For purposes of this subsection, a "weapon" means any firearm, or any weapon of the kind usually known as slung shot, sand club, or metal knuckles, or any knife, dagger, dirk, or other similar weapon that is capable of causing death or bodily injury and is commonly used with the intent to cause death or bodily injury, but the definition of weapon shall specifically exclude an ordinary pocket knife or any softball-related equipment.
Effect-Section 12A-D: The first offense is a team warning. Any repeat offense shall result in the ejection of that team member.
- D. A participant who is hearing-impaired may use a sign language interpreter or other auxiliary hearing aid during play to assist that hearing-impaired participant. A sign language interpreter shall be allowed in the dugout, on the field of play (fair or foul territory), or in other areas to be able to provide communication to the hearing-impaired participant, but such sign language interpreter shall be subject to any other rules, policies, or practices generally applicable to participants, including submitting to and passing an annual background check screening, if applicable. Any concerns, issues or requests concerning the specific location of such interpreters on the field of play shall be resolved by the umpire(s) during gameplay and such concerns or requests shall be addressed to and resolved by the applicable Local Association Member, league, tournament director, and/or event organizer in advance of gameplay. It is highly recommended that participants provide notice of such requests to the applicable Local Association Member, league, tournament director, and/or event organizer sufficiently in advance of and prior to or during the league or tournament registration process prior to the start of a season or tournament.

RULE 6 - PITCHING REGULATIONS

SECTION 1 – PRELIMINARIES

Before starting the delivery (pitch), the pitcher shall comply with the following:

- A. When taking the pitching position in contact with the pitcher's plate, the pitcher must have their hands separated and must have the ball in either the glove or the pitching hand.
- B. The pitcher shall not be considered in the pitching position unless the catcher is in position to receive the pitch.
- C. Both feet must be on the ground within the 24-inch length of the pitcher's plate. The shoulders shall be in line with first and third bases. The pitcher shall take a position with their pivot foot in contact with the pitcher's plate and their non-pivot foot in contact with or behind the pitcher's plate.
- D. While in contact with the pitcher's plate, the pitcher shall take a signal or appear to take a signal with the hands separated. The ball must remain in either the glove or pitching hand.
- E. The pitcher shall bring the hands together for not less than one second and not more than 10 seconds before releasing the ball; a backward step may be taken before, simultaneous with or after the hands are brought together. The pivot foot must always remain in contact with the pitcher's plate prior to the forward step.

SECTION 2 - STARTING THE PITCH

The pitch starts when the hands are separated once they have been placed together.

Effect: Illegal pitch; refer to Rule 6A Section 11 for penalty.

SECTION 3 - LEGAL DELIVERY

- A. The pitcher shall not make any motion to pitch without immediately delivering the ball to the batter.
- B. The pitcher shall not use a pitching motion in which, after bringing the hands together, the pitcher removes one hand from the ball and returns the ball to both hands.
- C. The pitcher shall not make a stop or reversal of the forward motion after separating the hands.
- D. The pitcher shall not make two revolutions of the arm on the windmill delivery. A pitcher may drop the arm to the side and to the rear before starting the windmill motion.
- E. The delivery shall be an underhand motion with the hand below the hip and the wrist not farther from the body than the elbow.
- F. The pitch shall be delivered on the throwing arm side of the body and not behind the back or through the legs.
- G. The release of the ball and follow through of the hand and wrist must be forward and past the straight line of the body.
- H. In the act of delivering the ball, the pitcher shall take one step with the non-pivot foot simultaneous with the release of the ball. The step must be forward and toward the batter within the 24-inch length of the pitcher's plate. It is not a step if the pitcher slides the pivot foot across the pitcher's plate toward the batter, or if the pivot foot turns or slides to push off the pitcher's plate, provided contact is maintained with the

plate. Raising the foot off the pitcher's plate and returning it to the plate creates a rocking motion and is an illegal act.

- I. Pushing off with the pivot foot from a place other than the pitcher's plate is illegal.
- J. The pitcher shall not make another revolution after releasing the ball.
- K. The pitcher shall not deliberately drop, roll, or bounce the ball to prevent the batter from hitting it.

Effect - Section 3 [A-N]: Illegal pitch; refer to Rule 6A Section 11 for penalty.

- L. The pitcher has 20 seconds to release the next pitch after receiving the ball or after the umpire indicates "play ball."

Effect: A ball on the batter.

- M. If the ball slips from the pitcher's hand during the delivery

Effect:

1. The ball remains live.
2. A ball on the batter.
3. Runners may advance at their own risk.

SECTION 4 - INTENTIONAL WALK

If the pitcher desires to intentionally walk a batter, all pitches must be legally delivered.

SECTION 5 – DEFENSIVE POSITIONING

- A. The pitcher shall not deliver a pitch unless all defensive players are positioned in fair territory, except the catcher who shall be in the catcher's box.
- B. A fielder shall not take a position in the batter's line of vision, with deliberate un-sportsmanlike intent, or act in a manner to distract the batter. A pitch does not have to be released.

Effect: The offending player shall be ejected from the game.

Effect - Section 5A&B: Illegal pitch; refer to Rule 6A Section 11 for penalty.

SECTION 6 - FOREIGN SUBSTANCE/PROTECTIVE WRAPS

- A. A defensive player shall not, at any time during the game, be allowed to use any foreign substance upon the ball, pitching hand or fingers. Under the supervision and control of the umpire, powder resin and/or an approved drying agent that is included on the list published by USA Softball may be used by the pitcher. The resin must be left on the ground and the approved drying agent in the pitcher's pocket. A pitcher who licks their fingers must wipe the fingers off before bringing them in contact with the ball. **Effect:** Illegal pitch; refer to Rule 6A Section 11 for penalty.
- B. A pitcher shall not wear any item on the pitching hand, wrist, forearm, elbow, or thighs which may, in the umpire's judgment, be distracting to the batter. Batting gloves shall not be worn on the pitching hand.

SECTION 7 - CATCHER

- A. The catcher shall remain within the lines of the catcher's box until the pitch is released.

Effect: Illegal pitch; refer to Rule 6A Section 11 for penalty.

- B. The catcher shall return the ball directly to the pitcher after each pitch, except after a strikeout, a put out or an attempted put out made by the catcher.

Effect: A ball on the batter.

Exception: Does not apply with runners on base or the batter becoming a batter-runner.

SECTION 8 - THROWING TO A BASE

The pitcher shall not throw to a base during a live ball while either foot is in contact with the pitcher's plate after taking the pitching position. If a throw from the pitcher's plate occurs during a live ball appeal, the appeal is canceled. The pitcher may remove themselves from the pitching position by stepping back off the pitcher's plate prior to separating their hands. Stepping forward or sideways is illegal.

Effect:

Illegal Pitch

1. Ball on the batter.

SECTION 9 - WARM-UP PITCHES

At the beginning of each half inning, or when a pitcher relieves another pitcher, not more than one minute may be used to deliver not more than five pitches. Play shall be suspended during this time. A pitcher returning to pitch in the same half inning will not receive warm-up pitches. There is no limitation as to the number of times a player can return to the pitching position if the player is legally in the game.

Effect: For excessive warm-up pitches award a ball to the batter for each pitch more than five. This does not apply if the umpire delays the start of play due to substitution, conference, injuries, or other umpire responsibilities.

SECTION 10 - NO PITCH

No pitch shall be declared:

- A. When the pitcher pitches during the suspension of play.
- B. When the pitcher attempts a quick return of the ball before the batter has taken a position in the batter's box or when the batter is off balance.
- C. When a runner is called out for leaving a base prior to the pitcher releasing the ball.
- D. When a pitch is delivered before a runner has retouched their base after being legitimately off that base.
- E. When a player, manager, or coach calls time, employs any other word or phrase, or commits any act while the ball is live for the obvious purpose of trying to make the pitcher commit an illegal pitch. A warning shall be issued to the offending team, and a repeat of this type of act by any member of the team warned shall result in the offender being ejected from the game.

Effect - Section 10A-E: Dead ball. All subsequent action on that pitch is canceled.

SECTION 11 - ILLEGAL PITCH PENALTY

- A. If the batter reaches first base safely and each other base runner advances at least one base, the play stands, and the illegal pitch is canceled.
- B. If the batter does not reach first base safely or if any runner fails to advance at least one base, the coach of the offensive team may choose the result of the play or the standard effect for an illegal pitch, a ball on the batter.
- C. If the batter is hit by an illegal pitch not swung at, the batter is awarded first base, and other base runners are advanced one base only if forced.

RULE 7 - BATTING

SECTION 1 - ON-DECK BATTER

- A. The on-deck batter shall take a position within the lines of the on-deck circle nearest the offensive team area.
Exception: May take a position within either on-deck circle as long as the on-deck batter is behind the batter and not on the batter's open side.
- B. The on-deck batter may loosen up with no more than two official softball bats, an approved warm-up bat, or a combination not to exceed two. Any attachment placed on the bat must be approved by USA Softball.
- C. The on-deck batter may leave the on-deck circle:
 - 1. When they become the batter.
 - 2. When directing runners advancing from third base to home plate.
- D. The on-deck batter may not interfere with a defensive player's opportunity to make an out.
Effect:
 - 1. The ball is dead.
 - 2. If it involves a runner, the runner closest to home plate at the time of the interference shall be declared out.
 - 3. If it is with the defensive fielder fielding a fly ball, the batter is out.

SECTION 2 - BATTING ORDER

- A. The batting order shall show the names, first and last, in the order in which the players are scheduled to bat.
- B. The batting order delivered to the umpire must be followed throughout the game unless a player is replaced by:
 - 1. A substitute who must take the place of the removed player in the batting order,
OR
 - 2. (Fast Pitch) The FLEX batting for the DP and remaining in the batting order until returning to the 10th position (or the last position in Junior Olympic Pool Play only) in the line-up.
- C. The first batter in each inning shall be the batter whose name follows the last player who completed a turn at bat in the previous inning.
Note - Section 2 B&C: Batting out of order is an appeal play that may be made by the

defensive team only. The appeal must be made before the next pitch, legal or illegal, before the pitcher and all infielders have vacated their normal fielding positions and have left fair territory; or on the last play of the game, until the umpires leave the field of play.

- D. If batting out of order is discovered:
 - 1. While the incorrect batter is at bat:
 - a. The correct batter must take the batter's position and assume the balls and strikes count.
 - b. Any runner advanced and runs scored while the incorrect batter was at bat shall be legal.
 - c. There is no penalty whether discovered by the offense or defense while the incorrect batter is at bat.
 - 2. After the incorrect batter has completed a turn at bat and before the next pitch, legal or illegal, before the pitcher and all infielders have vacated their normal fielding positions and have left fair territory; or on the last play of the game until the umpires leave the field of play:
Effect:
 - a. The incorrect batter's time at bat is negated.
 - b. The player who should have batted is out.
 - c. Any advancement or score of a runner because of the incorrect batter is negated. Runners not called out must return to the last base occupied at the time of the pitch. Any runner, who is called out prior to the discovery of the infraction, remains out.
 - d. The next batter is the player whose name follows that of the player called out for failing to bat.
 - 3. After a pitch, legal or illegal, to the next batter, or before the pitcher and all infielders have vacated their normal fielding positions and have left fair territory; or on the last play of the game, until the umpires leave the field of play:
Effect:
 - a. The turn at bat of the incorrect batter is legal.
 - b. All runs scored, runners advanced, and outs made are legal.
 - c. The next batter shall be that player whose name follows that of the incorrect batter.
 - d. No out is called for failure to bat.
 - e. Players who have not batted and who have not been called out have lost their turn at bat until their spot in the batting order is reached again.
 - 4. Runners shall not be removed from the base occupied, except the batter-runner who has been removed from a base by the umpire as in (2) above to bat in the proper position. The correct batter misses their turn at bat with no penalty. The batter following the correct batter in the batting order becomes the legal batter.
- E. Pool Play: Nine defensive players will bat, or teams have the option of having up to and including all roster players present bat.

Effects: Rule 1 Definition, Rule 4 Section 1C [1C], Rule 4 Section 1D [2A], Rule 4 Section 3B, Rule 4 Section 4, Rule 4 Section 6D, Rule 8 Section 10C.

- F. When the third out in an inning is made before the batter has completed their turn at bat, that player shall be the first batter in the next inning.

SECTION 3 - BATTING POSITION

- A. Prior to the pitch, the batter must have both feet completely within the lines of the batter's box. The batter may touch the lines, but no part of the foot may be outside the lines prior to the pitch.
- B. The batter must take the batter's position in the batter's box within 10 seconds after being directed to do so by the umpire.

Effect:

1. The ball is dead.
2. A strike on the batter.

Note: No pitch must be thrown.

- C. After entering the batter's box, the batter must remain in the box with at least one foot between pitches and while taking signals and practice swings.

Exceptions: The batter may leave the box:

1. When the ball is batted fair or foul.
2. On a swing, slap, or check swing.
3. When forced out of the box by a pitch.
4. On a wild pitch or passed ball.
5. When a play is attempted.
6. When time has been called.
7. When the pitcher leaves the 8-foot circle, or the catcher leaves the catcher's box.
8. When the count reaches three balls, and the next pitch is a strike that the batter thinks is a ball.

Effect: If the batter leaves the batter's box and delays play, for any other reason than 1-8 above:

- a. The ball is dead.
- b. The umpire may warn the batter or
- c. Call a strike.
- d. Any number of warnings and called strikes can be made with each batter.

Note: No pitch must be thrown.

- D. The batter shall not step directly in front of the catcher to the other batter's box while the pitcher is taking the signal.

Effect:

1. The ball is dead.
2. The batter is out.
3. Runners may not advance.

- E. After the ball is live, the batter may not step out of the batter's box to stop play unless time has been granted by the umpire.

Effect:

1. All play shall continue.
2. The pitch will be judged a ball or strike.

SECTION 4 - A STRIKE ON THE BATTER

- A. For each legally pitched ball entering the strike zone.

Effect:

1. The ball remains live.
2. Runners may advance with liability to be put out.

- B. For each legally pitched ball swung at and missed by the batter.

Effect:

1. The ball remains live.
2. Runners may advance with liability to be put out.

- C. For each foul tip.

Effect:

1. The ball remains live.
2. Runners may advance with liability to be put out.
3. The batter is out if it is the third strike.

- D. For each foul ball when the batter has fewer than two strikes.

- E. For each pitched ball swung at and missed which touches any part of the batter.

- F. If a pitched ball is swung at, missed, and then hit on the follow through.

- G. When any part of the batter's person or clothing is hit with a batted ball while the batter is in the batter's box and has fewer than two strikes.

- H. When a legally pitched ball hits the batter while the ball is in the strike zone.

- I. When a pitched ball is prevented from entering the strike zone by any actions of the batter other than hitting the ball.

Effect - Section 4 H-I:

1. The ball is dead.
2. A strike on the batter.
3. Each runner must return to the base occupied at the time of the pitch.

- J. If the batter does not take their position in the batter's box within 10 seconds after being directed by the umpire.

- K. When, between pitches, the batter leaves the batter's box illegally or does not return to the box after a warning.

Effect - Section 4 M&N:

1. The ball is dead.
2. A strike on the batter.

SECTION 5 - A BALL ON THE BATTER

- A. (Fast Pitch) For each legally pitched ball that does not enter the strike zone, touches the ground before reaching home plate, or touches home plate, and the batter does not

swing.

Effect:

1. The ball remains live.

2. Runners are entitled to advance with liability to be put out.

B. For each illegally pitched ball not swung at or swung at and missed.

Effect: Illegal Pitch

1. Ball on the batter.

C. When the catcher fails to return the ball directly to the pitcher as required.

D. For each excessive warm-up pitch.

Effect - Section 5 E-H:

1. The ball is dead.

2. Runners may not advance.

SECTION 6 - THE BATTER IS OUT

A. When the third strike is:

1. Swung at and the pitched ball touches any part of the batter's person.

2. Not swung at, and the pitched ball hits the batter while the pitch is in the strike zone.

3. A pitched ball, in the umpire's judgment, which was prevented from entering the strike zone by actions of the batter other than hitting the ball.

B. When a batter enters the batter's box with or is discovered using an Altered or Non-Approved bat.

Effect:

1. The batter is out.

2. Ejected.

3. If in a tournament, may be subject to future penalties by the Tournament Protest Committee.

C. When discovered using an Altered or Non-Approved bat after completing their turn at bat and before the next pitch, legal or illegal.

Effect:

1. The batter is out.

2. Ejected.

3. If in a tournament, the player may be subject to future penalties by the Tournament Protest Committee.

4. All outs stand.

5. All other runners return to the base occupied at the time of the pitch.

D. When the batter enters the batter's box with or is discovered using an Illegal bat.

Effect: The batter is out.

E. When discovered using an Illegal bat after completing their turn at bat and before the next pitch, legal or illegal.

Effect:

1. The batter is out.

2. All outs stand.

3. All other runners return to the base occupied at the time of the pitch.

Note - Section 6 B-E: If a previous batter has used the same Altered, Non-Approved, or Illegal bat and a pitch, legal or illegal, has been thrown, the current batter is out.

F. When an entire foot is touching the ground completely outside the lines of the batter's box at the time the ball contacts the bat.

G. When any part of a foot is touching home plate at the time the ball contacts the bat.

H. When a batter leaves the batter's box and returns to the box and contacts the ball.

I. When the batter bunts foul after the second strike. If the ball is caught before touching the ground, it remains live.

J. When members of the team at bat, including those in the team area other than runners, interfere with a player attempting to field a fair or foul fly ball.

K. When the batter hits a fair ball with the bat a second time in fair territory.

Effect - Section 6 F-M:

1. The ball is dead.

2. The batter is out.

3. Runners must return to the base occupied at the time of the pitch.

Exception:

4. When the batter is in the batter's box and contact is made while the bat is in the batter's hands.

Effect: Foul ball, even if the ball is hit a second time over fair territory.

5. When the batter drops the bat and the ball rolls against the bat in fair territory, and, in the umpire's judgment, there was no intent to interfere with the ball.

Effect: The ball remains live.

6. When contact is made on the follow through after missing the pitch on the initial swing.

Effect:

a. The ball is dead.

b. A strike is called.

L. When a called or swinging third strike is caught by the catcher.

M. When the batter has three strikes and/or if there are fewer than two outs and first base is occupied at the time of the pitch.

N. Whenever the batter due up has left the game under the Short-Handed Rule.

O. When hindering the catcher from catching or throwing the ball by stepping out of the batter's box.

P. When actively hindering the catcher while in the batter's box.

Q. When intentionally interfering with a thrown ball, in or out of the batter's box.

R. When interfering with a play at home plate.

Effect - Section 6 R-U:

1. The ball is dead.

2. The batter is out.

3. Each runner must return to the last base touched at the time of the interference.
Exception: If no play is being made and the batter accidentally contacts the catcher's return throw to the pitcher.

Effect:

- a. The ball is dead.
- b. Any advancement of runners shall be nullified.

RULE 8 - BATTER-RUNNER AND RUNNER

SECTION 1 - THE BATTER BECOMES A BATTER-RUNNER

- A. As soon as the batter legally hits a fair ball.
- B. When the catcher fails to catch the third strike before the ball touches the ground and there are:
 1. Fewer than two outs and first base is not occupied at the time of the pitch, or
 2. Any time there are two outs.
- C. When four balls have been called by the umpire. The batter-runner is awarded first base.
Effect:
 1. The ball is live.
- D. When the catcher obstructs a batter's attempt to hit a pitched ball.
Effect: Delayed dead ball.
 1. If the batter hits the ball and reaches first base safely or has passed that base and is considered to have reached it, and all other runners have advanced at least one base.
Effect:
 - a. Obstruction is canceled.
 - b. All action because of the batted ball stands.
 - c. No option is given.
 2. If all runners, including the batter-runner, do not advance at least one base.
Effect:
 - a. The manager has the option of taking the result of the play, or
 - b. Enforcing obstruction by awarding the batter first base.
 - c. Runners are advanced one base if forced.
 3. The catcher steps on or in front of home plate without the ball and prevents the batter from hitting the ball.
Effect:
 - a. The ball is dead.
 - b. The batter is awarded first base.
 - c. Runners are advanced one base if forced.
 4. On a swing or attempted bunt, the catcher or any other fielder prevents the batter from hitting the ball, touches the batter or their bat with a runner on third base

trying to score on a squeeze play or a steal.

Effect:

- a. The ball is dead.
- b. The runner shall be awarded home plate.
- c. The batter shall be awarded first base.
- d. Runners are advanced one base if forced.

- E. When a fair batted ball strikes the person, attached equipment or clothing of an umpire or a runner:
 1. After touching a fielder including the pitcher.
 2. After passing a fielder other than the pitcher and no other fielder had an opportunity to make an out.
Effect - Section 1 E [1 & 2]: The ball remains live.
 3. Before passing a fielder without being touched.
 4. Before passing a fielder, excluding the pitcher and contacts a runner who is off the base.
 5. After passing a fielder and another fielder can make an out.
Effect - Section 1 E [3-5]:
 - a. The ball is dead.
 - b. The runner is out.
 - c. The batter-runner is awarded first base.
 - d. Runners are advanced one base if forced.
 6. While the runner is in contact with a base.
Effect:
 - a. The runner is not out.
 - b. The ball is live, or dead depending on the position of the fielder closest to the base.
 7. Or contacts an umpire before passing a fielder other than the pitcher.
Effect:
 - a. The ball is dead.
 - b. The batter-runner is awarded first base.
 - c. Runners are advanced one base if forced.
- F. When a pitched ball, not swung at nor called a strike, touches any part of the batter's person including the hands or clothing. The batter's hands are not part of the bat.
Effect:
 1. The ball is dead.
 2. The batter is awarded first base.
Exception: If no attempt is made to avoid being hit, the batter will not be awarded first base unless it is ball four.

SECTION 2 - THE BATTER-RUNNER IS OUT

- A. When the catcher drops the third strike, and the batter-runner is put out prior to reaching first base. This is in effect if there are two outs or with less than two outs and first base is not occupied at the time of the pitch.
- B. After hitting a fair ball and the batter-runner is put out prior to reaching first base.
- C. After hitting a fly ball that is caught by a fielder before it touches the ground, any object or person other than a defensive player.

Effect - Section 2 A-C: The ball remains live.

- D. When the batter-runner fails to advance to first base and enters the team area after:
 - 1. A batted fair ball.
 - 2. A base on balls.
 - 3. A dropped third strike.
 - 4. Catcher Obstruction.
- E. When the batter-runner runs outside the three-foot lane and, in the umpire's judgment, interferes with the fielder taking the throw at first base. The batter-runner may run outside the three-foot lane to avoid a fielder attempting to field a batted ball. When the defensive player uses the foul portion of the double base, the batter-runner can run in fair territory when the throw is coming from the foul side of first base, and if hit by the thrown ball, it is not interference. If intentional interference is ruled, the runner is out.
- F. When the batter-runner interferes:
 - 1. With a fielder attempting to field a batted ball.
 - 2. With a fielder attempting to throw the ball.
 - 3. With a thrown ball while out of the batter's box.
 - 4. By contacting a fair batted ball before reaching first base.
 - 5. By discarding their bat in a manner that prevents the defense from making a play on the ball.
 - 6. With a dropped third strike.

Note: If this interference is an attempt to prevent a double play, the runner closest to home plate shall be called out.

- G. When the batter-runner interferes with a play at home plate to prevent an out at home plate.

Effect: The runner is also out.

- H. When the batter-runner steps back toward home plate to avoid or delay a tag by a fielder.

Effect - Section 2D-H:

- 1. The ball is dead.
- 2. The batter-runner is out.
- 3. Runners must return to the last base touched at the time of the interference.
- I. When an infield fly is declared.
- J. When an infield fly is declared, and the fair batted ball hits the batter-runner before reaching first base.

Effect:

- 1. The ball is dead.
- 2. The infield fly is invoked.
- K. When an infielder intentionally drops a fair fly ball, including a line drive or a bunt, which can be caught with ordinary effort with first, first and second, first and third or first, second and third bases occupied with fewer than two outs.

Effect:

 - 1. The ball is dead.
 - 2. The batter-runner is out.
 - 3. Runners must return to the base occupied at the time of the pitch.
 - 4. If an infield fly is ruled, it has precedence over an intentionally dropped ball.
- L. When the immediate previous runner who is not out intentionally interferes, in the umpire's judgment, with a fielder who is attempting to catch a thrown ball or throw a ball to complete the play on the batter-runner.

Effect:

 - 1. The ball is dead.
 - 2. The batter-runner is out.
 - 3. Runners must return to the base occupied at the time of the pitch.
- M. The double base shall be used at first base in all divisions of play. The following rules should be enforced:
 - 1. A batted ball hitting or bounding over the white portion is fair.
 - 2. A batted ball hitting or bounding over the contrasting color portion is foul.
 - 3. When a play is being made on the batter-runner, the defense must use the white portion and the batter-runner the contrasting color portion of the base.

Effect: The batter-runner is out when there is a play being made at first base and the batter-runner touches only the white portion, providing the defense appeals prior to the batter-runner returning to first base. Once the runner returns to the white or contrasting color portion of the base, an appeal shall not be honored.
 - 4. On any force out attempt from the foul side of first base the defense and the batter-runner may use either the white or contrasting color portion of the base.
 - 5. On an errant throw pulling the defense off the white portion of the base into foul ground, the defense and the batter-runner can use either the white or contrasting color portion.
 - 6. Once the batter-runner reaches first base, they may start on either the white or contrasting color portion of the entire base.
 - 7. On balls hit to the outfield with no play on the batter-runner advancing to first base, the batter-runner may touch the white or contrasting color portion. Should the batter-runner return, the runner and defense can use the white or contrasting color portion.
 - 8. When tagging up on a fly ball, the white or contrasting color portion of the base may be used. On an appeal for the runner leaving the base too soon, the defense may use the white or contrasting color of the base.

9. On an attempted pick-off play, the runner may return to the white or contrasting color portion of the base.
10. On plays at 1B when the batter-runner touches only the white portion and collides with the fielder about to catch a thrown ball while on the white portion of the base.

Effect:

- a. The ball is dead.
- b. The batter-runner is out.
- c. Runners must return to the last base touched at the time of the interference.

- N. When a spectator reaches into live ball territory and interferes with a fielder's opportunity to catch a fly ball.

Effect:

1. The ball is dead.
2. The batter-runner is out.
3. Runners are awarded the bases that in the umpire's judgment would have been reached had the interference not occurred.

SECTION 3 - TOUCHING BASES IN LEGAL ORDER

- A. When a runner must return to a base while the ball is live, or dead, the bases must be touched in reverse order.

Effect: If properly appealed the runner is out.

Exception: On a foul ball.

- B. When a runner or batter-runner acquires the right to a base by touching it before being put out, the runner or batter-runner is entitled to hold that base until legally touching the next consecutive base or is forced to vacate it for a trailing runner. When a runner passes a base, the runner is considered to have touched that base. This also applies to awarded bases.

- C. When a runner dislodges a base from its proper position, that runner and all trailing runners are not required to follow a base out of position.

Effect - Section 3B-C:

1. The ball remains live.
2. Runners may advance or return with liability to be put out.

- D. A runner shall not run bases in reverse order to confuse the fielders nor to make a travesty of the game.

Effect:

1. The ball is dead.
2. The runner is out.

- E. Two runners may not occupy the same base at the same time.

Effect:

1. The runner who first legally occupied the base is entitled to that base, unless forced to advance.
2. The other runner may be put out by being tagged with the ball.

- F. Failure of a previous runner to touch a base or to legally tag up on a caught fly ball, and who is declared out, does not affect the status of a trailing runner who touches bases in proper order. If the failure to touch a base in regular order or to legally tag up on a caught fly ball is the third out of the inning, no trailing runner may score a run.
- G. No runner may return to touch a base missed or one left too soon after a trailing runner has scored or once they leave live ball territory.
- H. Bases left too soon on a caught fly ball must be retouched prior to advancing to awarded bases.
- I. Awarded bases must be touched in legal order.

SECTION 4 - RUNNERS ARE ENTITLED TO ADVANCE WITH LIABILITY TO BE PUT OUT

- A. When the ball leaves the pitcher's hand on the delivery.
- B. On a thrown ball or a fair batted ball that is not blocked.
- C. On a thrown ball that hits an umpire.
- D. When a legally caught fly ball is first touched by a defensive player.
- E. If a fair ball:
 1. Contacts an umpire or a runner after having passed a fielder other than the pitcher, provided no other fielder had a chance to make an out, or:
 2. When a fair batted ball has been touched by a fielder, including the pitcher, and the runner did not intentionally interfere with the batted ball or the fielder attempting to field the batted ball.

Effect - Section 4A-E: The ball remains live.

- F. When a live ball becomes lodged in a defensive player's uniform or equipment.
- G. When a runner fails to touch a base before attempting to make the next base while the ball is live or when bases have been awarded.
- H. After overrunning first base, the runner attempts to continue to second base.
- I. After dislodging a base, a runner attempts to continue to the next base.
- J. When an infield fly is declared and caught runners may tag-up and advance. If the ball is not caught runners may advance at their own risk.

SECTION 5 - RUNNERS ARE ENTITLED TO ADVANCE WITHOUT LIABILITY TO BE PUT OUT

- A. When forced to vacate a base because the batter was awarded a base on balls.

Effect:

1. The ball remains live unless it is blocked.
2. Any runner affected is entitled to one base and may advance farther with liability to be put out.

- B. When a fielder not in possession of the ball or not in the act of fielding a batted ball obstructs the progress of a runner or batter-runner.

Effect: Delayed dead ball.

1. An obstructed runner may not be called out between the two bases where obstructed.

Exceptions:

- a. When an obstructed runner, after the obstruction, safely obtains the base they would have been awarded, in the umpire's judgment, had there been no obstruction and there is a subsequent play on a different runner.
 - b. An act of interference, or
 - c. If passing another runner.
Effect A-C: The obstructed runner is no longer protected between the bases where obstructed and may be put out.
 - d. Missing a base.
 - e. Leaving a base before a fly ball was first touched.
Effect D-E: The obstructed runner is out if properly appealed.
2. If the obstructed runner is put out prior to reaching the base which would have been reached had there been no obstruction.
Effect:
- a. The ball is dead.
 - b. The obstructed runner and all other runners shall always be awarded the base or bases which would have been reached, in the umpire's judgment, had there been no obstruction.
3. If the obstructed runner is put out after passing the base which would have been reached had there been no obstruction or advanced beyond the two bases where the obstruction occurred,
Effect:
- a. The ball remains live.
 - b. The obstructed runner is called out.
4. When a runner, while advancing or returning to a base:
- a. Is obstructed by a fielder who neither has the ball or
 - b. Is attempting to field a batted ball, or
 - c. When a fielder fakes a tag without the ball
Effect:
- i. The obstructed runner and all other runners shall always be awarded the base or bases which would have been reached, in the umpire's judgment, had there been no obstruction.
 - ii. In the umpire's judgment, a defensive player making a fake tag could be ejected from the game.
Note 1: Obstructed runners are required to touch all bases in proper order and may be called out if properly appealed.
Note 2: Should an act of interference occur following any obstruction, the interference takes precedence.
- C. When a pitched ball that remains live becomes blocked or goes out of live ball territory.
Effect:
- 1. The ball is dead.
 - 2. The batter is awarded first base on ball four.
 - 3. Runners are awarded one base only.
- D. When forced to vacate a base because the batter was awarded first base.
- E. When a pitcher makes an illegal pitch, providing the offensive coach does not take the result of the play.
Exception: Runners are not entitled to advance.
- F. When a fielder intentionally contacts or catches a fair batted, thrown, or pitched ball with any part of the uniform or equipment that is detached from its proper place.
Effect: Delayed dead ball. The batter and runners are entitled to:
- 1. Three bases from the time of the pitch on a batted ball.
 - 2. Two bases from the time of the throw on a thrown ball.
 - 3. One base from the time of the pitch on a pitched ball.
 - a. In all games with stealing, runners may advance farther with liability to be put out.
 - b. A batter is awarded one base only on the third strike.
 - 4. If the illegal catch or touch is made on a fair batted ball which, in the umpire's judgment, would have cleared the outfield fence in flight, the batter-runner shall receive a four-base award.
 - 5. On a pitched ball that eludes the catcher and is retrieved with detached equipment, there is no penalty if:
 - a. Runners are not advancing,
 - b. No apparent play is possible,
 - c. No advantage is gained.
- G. When the ball is live and is overthrown or is blocked:
Effect:
- 1. All runners shall be awarded two bases.
 - 2. The award shall be governed by the position of the runners when the ball left the fielder's hand.
Note: Runners must return to touch a base missed or left too soon. When two runners are between the same two bases, the award is based on the position of the lead runner. Once a base runner advances to the next awarded base, the runner may no longer return to touch any base missed or left too soon.
Exception:
- a. When a fielder loses possession of the ball, and the ball leaves live ball territory or becomes blocked.
Effect:
- i. The ball is dead.
 - ii. Each runner is awarded one base from the last base touched at the time the ball entered dead ball territory or became blocked.
- b. When the ball becomes dead, runners must return to touch a base missed or left too soon if they have advanced, touched, and are a base beyond the base missed or left too soon.
Note: Runners must be given the opportunity to complete their base running responsibilities. A runner shall not be declared out if a fielder deliberately

carries or throws the ball into dead ball territory to prevent that runner from returning to a base missed or left too soon. Once a runner leaves live ball territory, they cannot return to touch any base missed or left too soon.

- c. If the ball becomes blocked due to offensive equipment not involved in the game.

Effect:

- i. The ball is dead.
- ii. Runners are returned to the last base touched at the time of the blocked ball.
- iii. If the blocked ball prevented the defense from making an out, the runner being played on is out.

- d. If a base is awarded in error, after a legal or illegal pitch the error cannot be corrected.

- H. When a fair batted fly ball strikes the foul pole above the fence level or leaves the playing field in fair territory without touching the ground or going through the fence.

Effect: The batter-runner shall be entitled to a home run, unless it passes out of the grounds at a distance less than the prescribed fence distances from home plate, in which case the batter-runner is entitled to two bases.

- I. When a fair batted ball:

1. Bounces over, rolls under or through a fence or any designated boundary of the playing field.
2. Deflects off the defensive player and goes out of play.
3. Hits the fence and then deflects off the defensive player and goes over the home run fence.
4. Deflects off a runner or umpire and goes out of play, after passing an infielder, excluding the pitcher and provided no other fielder had a chance to make an out.

Effect:

- a. The ball is dead.
- b. All runners are awarded two bases from the time of the pitch.

- J. When a live ball is unintentionally carried by a fielder from live ball territory, or a fielder carries a live ball into the team area to tag a player.

Effect:

1. The ball is dead.
2. Runners are awarded one base from the last base touched at the time the fielder left live ball territory.

- K. When, in the judgment of the umpire, a fielder intentionally carries, kicks, pushes, or throws a live ball into dead ball territory.

Effect:

1. The ball is dead.
2. Runners are awarded two bases from the last base touched at the time the fielder entered or the ball was kicked, pushed, or thrown into dead ball territory.

- L. When there is spectator interference with any thrown or fair batted ball.

Effect:

1. The ball is dead.
2. The batter and runners are awarded the bases they would have reached had there been no interference.

- M. When a ball gets lodged in an:

1. Umpire's gear or clothing.
2. Offensive player's clothing.

Effect:

- a. The ball is dead.
- b. Runners are awarded the bases they would have reached in the judgment of the umpire.

SECTION 6 - A RUNNER MUST RETURN TO THEIR BASE

- A. When a batted ball is foul.

- B. When an illegally batted ball is declared by the umpire.

- C. When a batter, batter-runner or runner is called out for interference. All other runners shall return to the last base touched at the time of the interference.

- D. When any part of the batter's person or clothing is touched by a pitched ball that is swung at and missed.

- E. When the batter is hit by a pitched ball, unless forced.

Effect - Section 6A-E:

1. The ball is dead.
2. All runners must return to their base without liability to be put out, except when forced to advance to the next base because the batter became a batter-runner.
3. Runners are not required to touch the intervening bases while returning to a base.

- F. When the plate umpire interferes with the catcher's attempt to throw out a runner who is stealing, or an attempted pick off play.

Effect:

1. Delayed dead ball at the time of the interference. If the runner is ruled out, the ball remains live.
2. If the runner is not out, the ball becomes dead. Runners shall be returned to the base occupied at the time of the pitch.

Note: It is not umpire interference if, on a passed ball or wild pitch, the umpire gets hit by a thrown ball from the catcher. The ball remains live.

- G. When an intentionally dropped fly ball is ruled.

SECTION 7 - THE RUNNER IS OUT

- A. When running to any base in regular or reverse order and the runner runs more than three feet from the base path to avoid being touched by the ball in the hand or glove of a fielder.

- B. When the ball is live and while the runner is not in contact with a base, the runner is legally touched with the ball in the hand(s) of a fielder.

- C. When, on a force play, a fielder contacts the base while holding the ball or tags the runner before the runner reaches the base. If the forced runner, after touching the next base, retreats for any reason toward the base first occupied, the force play is reinstated, and the runner may again be put out if the defense tags the runner or the base to which the runner is forced.
Effect - Section A-C: The ball remains live.
- D. When a runner physically passes a preceding runner before that runner has been called out. If this was the third out of the inning, any runs scored prior to the out for passing a preceding runner count.
Effect:
1. The ball remains live.
 2. The runner who passes the preceding runner is out.
 3. Fast Pitch Only; On any over the fence home run all base runners and the batter-runner have live ball base running responsibilities. The batter-runner and any runner can be called out for passing a preceding runner. If this is the 3rd out any runs scored prior to the passing would count.
- E. When any offensive team member, other than another runner, physically assists a runner while the ball is live.
Effect:
1. The ball remains live.
 2. The runner being assisted is out.
Exception – Section E: After a runner has scored and missed home plate and then is physically assisted back to home plate:
 - a. The ball is dead.
 - b. The runner is out, and the run is nullified.
 - c. Runners must return to the last base touched at the time the ball became dead.
- F. When the runner leaves a base to advance to another base before a caught fly ball has touched a fielder, providing the ball is returned to the infield and properly appealed.
- G. When the runner fails to touch a base or bases in regular or reverse order and the ball is returned to the infield and properly appealed. If the runner put out is the batter-runner at first base, or any other runner forced to advance because the batter became a batter-runner, this is a force out.
- H. When the batter-runner legally overruns first base, attempts to run to second base and is legally touched with the ball while not in contact with the base.
- I. When running or sliding for any base and the runner fails to touch it, provided the defense properly appeals.
Effect - Section 7F-I:
1. These are appeal plays. The defensive team loses the opportunity of having the runner called out if any of the following occur.
 - a. The appeal is not made before the next pitch, legal or illegal.
 - b. The pitcher and all infielders have vacated their normal fielding positions and have left fair territory on their way to the team area, or
 - c. On the last play of the game the umpires have left live ball territory.
2. (Live Ball Appeal) If properly appealed by any defensive player during a live ball, the runner is out.
3. (Dead Ball Appeal) Once the ball has been returned to the infield and time is called, any coach or infielder with or without possession of the ball, may make a verbal appeal on a runner missing a base or leaving a base too soon on a caught fly ball. No runner may leave a base during this period as the ball remains dead until the next pitch.
 - a. If the ball leaves live ball territory, a dead ball appeal cannot be made until completion of all legal advancement by base runners.
 - b. If the pitcher has possession of the ball and is in contact with the pitcher's plate when making a verbal appeal, no illegal pitch is called.
 - c. If "play ball" has been declared by the umpire and the pitcher then requests an appeal, the umpire shall call "time" and allow the appeal process.
- J. When a runner interferes:
1. With a fielder attempting to field a batted fair ball or a foul fly ball, or
 2. With a fielder attempting to throw the ball, or
 3. With a thrown ball.
Effect:
 - a. The ball is dead.
 - b. The runner is out.
 - c. The batter-runner is awarded first base.
 - d. Runners must return to the last base touched at the time of the interference.
 - e. If the interference, in the umpire's judgment, is an attempt to prevent a double play and occurs before the runner is put out, the immediate trailing runner shall also be called out.
 - f. If the interference prevents the fielder from catching a routine fly ball, fair or foul, with ordinary effort, the batter is also out.
 4. Intentionally with any defensive player having the opportunity to make an out with the deflected batted ball.
Effect:
 - a. The ball is dead.
 - b. The runner is out.
 - c. The batter-runner is awarded first base.
 - d. Runners must return to the last base touched at the time of the interference.
- K. When a runner is struck with a fair untouched batted ball while not in contact with a base and before it passes an infielder, excluding the pitcher, or if it passes an infielder and another fielder has an opportunity to make an out.
- L. When a runner intentionally contacts a fair ball that an infielder missed.
Effect - Section 7K & L:

1. The ball is dead.
 2. The runner is out.
 3. The batter-runner is awarded first base.
 4. Runners must return to the last base touched at the time of the interference.
- M. When the coach near third base runs in the direction of home plate on or near the baseline while a fielder is attempting to make a play on a batted or thrown ball and thereby draws a throw to home plate.
- N. When members of the offensive team stand or collect around a base to which a runner is advancing, confusing the fielders, and adding to the difficulty of making the play.
- O. When a coach intentionally interferes with:
1. A batted ball.
 2. A thrown ball.
 3. The defensive team's opportunity to make a play on another runner.
Note: A batted or thrown ball that unintentionally hits a base coach is not considered interference.
- P. When, after being declared out or after scoring, an offensive player interferes with a defensive player's opportunity to make a play on another runner.
Note: A runner continuing to run and drawing a throw may be considered a form of interference. This does not apply to a batter-runner who is entitled to run on the dropped third strike rule.
Effect - Section 7M-P:
1. The ball is dead.
 2. The runner closest to home is out.
 3. Runners must return to the last base touched at the time of the interference.
- Q. When a defensive player has the ball, and the runner remains upright and crashes into the defensive player.
Effect:
1. The ball is dead.
 2. The runner is out.
 3. Runners must return to the last base touched at the time of the interference.
 4. If flagrant, the offender is ejected.
- R. When the runner fails to keep contact with the base to which the runner is entitled until the ball leaves the pitcher's hand.
Effect - Sections 7R-S:
1. The ball is dead.
 2. "No pitch" is declared.
 3. The runner is out.
- S. Look Back Rule. The "Look Back" rule shall be in effect for all runners when:
1. The ball is live.
 2. The batter-runner has reached first base or has been declared out.
 3. The pitcher has possession and control of the ball within the pitcher's circle. The pitcher is in the pitcher's circle when both feet are on or within the lines.
- a. When a runner is legitimately off a base after a pitch or because of a batter completing a turn at bat, and while the pitcher has control of the ball within the eight-foot radius of the pitcher's plate, the runner may stop once then must immediately return to the base or attempt to advance to the next base.
 - b. Once the runner stops at a base for any reason the runner will be declared out if leaving the base.
 - c. Responsibilities of the batter-runner after reaching first base, and while the pitcher has control of the ball within the eight-foot radius of the pitcher's plate, including a base on balls or a dropped third strike, are as follows:
 - i. A batter-runner who rounds first base toward second base may stop once, but then must immediately non-stop return to first base or attempt to advance non-stop to second base.
 - ii. A batter-runner who over-runs first base toward right field, turns left and immediately stops, must then return non-stop to first base, or attempt to advance non-stop to second base.
 - iii. A batter-runner who over-runs first base toward right field, turns left and moves directly toward second base and stops, is committed to second base, and must attempt to advance non-stop to second base.
 - iv. A batter-runner who overruns first base toward right field, turns left and moves back toward the infield in any direction except directly toward second base, is committed to first base and must return non-stop to first base.
 - v. A batter-runner who overruns first base toward right field, and turns right, is committed to first base, and must return non-stop to first base.
Effect - Section 7T [A-C]:
 - (a) The ball is dead.
 - (b) The runner is out.
 - (c) When more than one runner is off base, only one runner is called out.
 - (d) All other runners are returned to the last base touched.
Exception - Section 7T [A-C]: The runner will not be declared out if:
 - (e) A play is made on any runner. A fake throw is considered a play,
 - (f) The pitcher no longer has possession of the ball within the eight-foot radius, or
 - (g) The pitcher releases the ball on a pitch to the batter.
- T. When a runner abandons a base and enters the team area or leaves live ball territory.
Effect:
1. The ball is dead.
 2. The runner is out.
 3. Runners must return to the last base touched at the time of the infraction.

- U. When a runner is positioned behind and not in contact with a base to get a running start on any fly ball.
Effect:
 1. The ball remains live.
 2. The runner is out.
 3. Whenever a runner on base leaves the game under the Shorthanded Rule. (Rule 4, Section 1D)
- V. Prior to a legal or illegal pitch to the next batter, if the runner was discovered having used an Illegal, Altered or Non-Approved Bat.
Effect:
 1. The runner is out.
 2. If the bat was Altered or Non-Approved, the runner shall also be ejected.
- W. If the Illegal, Altered, or Non-Approved Bat is discovered prior to the next pitch, legal or illegal, any runners put out prior to the discovery shall remain out.
- X. When base runners switch positions on the bases, they occupied following any conference.
Effect: Each runner on an improper base shall be declared out. In addition, the manager shall be ejected for unsportsmanlike conduct.

SECTION 8 - THE RUNNER IS NOT OUT

- A. When a runner runs behind or in front of the fielder and outside the base path to avoid interfering with a fielder attempting to field a batted ball.
- B. When a runner does not run in a direct line to a base, provided the fielder in the direct line does not have the ball in their possession.
- C. When more than one fielder attempts to field a batted ball and the runner meets the one who, in the umpire's judgment, could not have made an out.
- D. When a runner is hit with a fair untouched batted ball that has passed an infielder, excluding the pitcher, and in the umpire's judgment, no other fielder had an opportunity to make an out.
- E. When a runner is hit with a fair untouched batted ball over foul territory that, in the umpire's judgment, no fielder had an opportunity to make an out.
- F. When a runner is hit by a fair batted ball after it touches or is touched by any fielder, including the pitcher, and the runner could not avoid contact with the ball.
- G. When a runner off a base:
 1. Is touched with a ball not securely held by a fielder.
 2. Is touched with a hand or glove of a defensive player and the ball is in the other hand.
- H. When the defensive team does not appeal:
 1. Until after the next legal or illegal pitch, or
 2. Until after the pitcher and all infielders have clearly vacated their normal fielding positions and have left fair territory on their way to the team area, or
 3. On the last play of the game, until the umpires have left live ball territory.

- I. When a batter-runner overruns first base after touching it and returns directly to the base.
- J. When the runner is not given sufficient time to return to a base.
Effect:
 1. The ball is dead.
 2. "No pitch" will be called by the umpire.
 3. The runner will not be called out for being off a base before the pitcher releases the ball.
- K. When the runner has legally started to advance.
Effect: The runner may not be stopped by the pitcher receiving the ball while on the pitcher's plate or by the pitcher stepping on the pitcher's plate with the ball in their possession.
- L. When the runner stays on the base until a fly ball is touched by a fielder and then attempts to advance.
- M. When hit by a batted ball while in contact with a base unless the runner intentionally interferes with the ball or a fielder making a play.
- N. When the runner slides into a base and dislodges it from its proper position. The base is considered to have followed the runner.
- O. When a fielder makes a play on a batter, batter-runner or runner while using an illegal glove/mitt, and it is discovered by the umpire before:
 1. The next legal or illegal pitch or
 2. The pitcher and all infielders have vacated their normal defensive positions and have left fair territory or
 3. On the last play of the game, the umpires have left live ball territory,
Effect: The manager of the offended team is given two options:
 - a. Have the entire play nullified with each runner returning to their original base and the batter batting again, assuming the ball and strike count prior to the pitch that was hit or on a steal attempt.
 - b. Take the result of the play.
- P. When a runner legally returns to a base left too soon or missed prior to an appeal being made or is returning to a base during a dead ball.

SECTION 9 - ADULT SLOW PITCH / MASTERS AND SENIOR FAST PITCH

This section has been removed as it applies to slow pitch only.

SECTION 10 - COURTESY RUNNERS

- A. The team at bat may use a courtesy runner:
 1. For the pitcher and/or the catcher providing the pitcher or catcher bats for themselves and reaches base safely.
 2. Neither the pitcher nor the catcher will be required to leave the game under such circumstances.
 3. The same courtesy runner may not run for both the pitcher and the catcher at any time during the game.

4. Defensive changes involving the pitcher or catcher must be reported to the umpire to ensure the correct player may have a courtesy runner.
- B. In the top of the first inning only, the pitcher and catcher are identified as those players listed on the line-up as the pitcher or catcher. Thereafter, the pitcher and catcher are identified as the last players who physically played that position on defense. If a substitute enters for the pitcher or catcher in the following offensive half-inning and reaches base safely, should the pitcher or catcher re-enter, the courtesy runner is not permitted for the pitcher or catcher until after their next turn at-bat.
- C. Players who are currently in the game or have participated in the game in any playing capacity are not eligible to serve as courtesy runners.

Exception: Junior Olympic Fast Pitch Pool Play only, any player can be used as a courtesy runner. If this player is on base when it is their time at bat:

1. The player who the courtesy runner is running for will be called out.
 2. The courtesy runner will be removed from the base and take their turn at bat.
- D. A player may not be a substitute for any player in the half inning that they participated as a courtesy runner.

Exception: Should an injury or disqualification occur, and no substitutes are available, the courtesy runner must be used as a substitute and take the place of the injured player. Should the courtesy runner be on base and is entered as a substitute, the pitcher or catcher for whom the courtesy runner is running must run in their place.

- E. If the DP bats for the pitcher or catcher and reaches base safely, a courtesy runner is not permitted to run for the Designated Player (DP), or their substitute, including the pitcher or catcher.
- F. Once the courtesy runner is designated for that half-inning, the pitcher or catcher for whom they are running may not return to run while that courtesy runner is on base. A courtesy runner cannot run for a courtesy runner.

Exception: Should an injury or disqualification occur to any offensive player, and no eligible substitutes are available, the courtesy runner must take the place of the injured or disqualified player. In this case, the courtesy runner enters as a substitute and the pitcher or catcher for whom the courtesy runner is running must run in their place.

- G. A courtesy runner must be reported to the plate umpire.

Effect - Section 10A-G: If a courtesy runner fails to report or violates the Courtesy Runner Rule, they are considered:

1. An illegal runner.
2. Shall be disqualified.

RULE 9 – PROTESTS

SECTION 1 - TYPES OF PROTESTS

There are three types of protests:

- A. Misinterpretation of a playing rule - must be made:
1. Before the next pitch legal or illegal.

2. Before the next play.
 3. Before all infielders have left fair territory.
 4. On the last play of the game before the umpires leave live ball territory.
- B. Illegal player - must be made while the player in question is in the game and before the umpires leave the playing field.
- Note A-B:** An umpire cannot reverse a decision after a pitch, legal or illegal.
- C. Ineligible player - can be made any time. Eligibility is the decision of the protest committee.

SECTION 2 – PROTESTS NOT CONSIDERED

Protests will not be considered if based solely on a decision involving the accuracy of judgment on the part of an umpire.

- A. Examples of protests which will not be considered are:
1. Whether a batted ball was fair or foul.
 2. Whether a runner was safe or out.
 3. Whether a pitched ball was a ball or a strike.
 4. Whether there is a legal or illegal pitch.
 5. Whether a runner did or did not touch a base.
 6. Whether a runner did or did not leave a base too soon on a caught fly ball.
 7. Whether a fly ball was or was not caught legally.
 8. Whether a batted ball was or was not an infield fly.
 9. Whether there was or was not interference or obstruction.
 10. Whether the field is or is not fit to continue or resume play.
 11. Whether there is or is not sufficient light to continue play.
 12. Whether a player or live ball did or did not leave the live ball territory or touch some object or person in a dead ball area.
 13. Whether a batted ball did or did not clear the fence in flight.
 14. Whether a batted ball was or was not touched by a fielder before clearing the fence in flight.
- B. Any other matter involving only the accuracy of the umpire's judgment.

SECTION 3 – PROTESTS ALLOWED

Protests may only involve the interpretation of a rule.

SECTION 4 - PROTEST NOTIFICATION

The manager, acting manager or captain of the protesting team shall immediately notify the plate umpire that the game is being played under protest. The plate umpire shall in turn notify the opposing manager and official scorekeeper. To aid in the correct determination of the issue, all interested parties shall take notice of the information, details and conditions surrounding the decision to protest.

SECTION 5 - PROTESTS OF ELIGIBILITY

Protest of eligibility can be made or appealed at any time. Eligibility protests cannot be waived by the Local Association.

SECTION 6 - WRITTEN PROTESTS

The written protest should contain the following information:

- A. The date, time, and place of the game.
- B. The names of the umpires and scorers.
- C. The rule and section of the official rules or local rules under which the protest is made.
- D. The information, details, and conditions relevant to the decision to protest.
- E. All essential facts concerning the matter protested.

SECTION 7 - RESULTS OF PROTEST

The decision rendered on a protested game must result in one of the following:

- A. The protest is invalid, and the game score stands as played.
- B. When a protest is determined to be valid because of the misinterpretation of a playing rule, the decision will be corrected, and the game shall be resumed from the point at which it was protested. If the protesting team wins the game the protest, then becomes meaningless.
- C. When a protest for ineligibility is determined to be valid, the offending team shall forfeit the game being played or the game last played to the offended team.

RULE 10 - UMPIRES

Failure of umpires to adhere to Rule 10 shall not be grounds for protest. These are guidelines for umpires.

SECTION 1 - POWER AND DUTIES

The umpires are representative of the league or organization by which they have been assigned to a particular game and, as such, are authorized and required to enforce each section of these rules. They have the power to order a player, coach, captain, or manager to carry out or to omit any act which, in their judgment is necessary to give force and effect to one or all these rules, and to impose penalties as herein prescribed. The plate umpire shall have the authority to make decisions on any situations not specifically covered in these rules. The following is the general information for umpires.

SECTION 2 - CHANGE OF UMPIRES

Teams may not request a change of umpires during a game. No umpire may be replaced during a game unless incapacitated by injury or illness.

SECTION 3 - UMPIRE'S JUDGMENT

- A. There will be no protest on any decision involving accuracy of judgment. No decision rendered by any umpire shall be reversed except when the umpire is convinced it is in

violation of one of these rules. In case the manager, acting manager or captain of either team does seek a reversal of a decision based solely on a point of rules, the umpire whose decision is in question, will, if in doubt, confer with the other umpire(s) before taking any action. Under no circumstances shall any player or person, other than the manager, acting manager or captain of either team, have the right to protest any decision and seek its reversal on a claim that it conflicts with these rules.

- B. Under no circumstances will any umpire seek to reverse a decision made by an associate, nor shall any umpire criticize or interfere with the duties of their associate(s), unless asked to do so.
- C. The plate umpire may rectify any situation in which the reversal of an umpire's decision or a delayed call by an umpire places a batter-runner, a runner, or the defensive team in jeopardy. This correction is not possible after one pitch legal or illegal, or after the pitcher and all infielders have clearly vacated their normal fielding positions and have left fair territory on their way to the bench or dugout area, or after the last play of the game, the umpires have left the field of play.

SECTION 4 - SUSPENSION OF PLAY

- A. Umpires may suspend play when, in their judgment, conditions justify such action.
- B. An umpire shall call time to perform other duties.
- C. The umpire shall suspend play whenever a batter or pitcher steps out of position for a legitimate reason.
- D. An umpire shall suspend play if a fair batted ball hits the umpire prior to passing an infielder.
Effect: The batter-runner is awarded a base hit. No runners are advanced unless forced to advance.
- E. An umpire shall not call time while any play is in progress, including when a thrown ball hits an umpire.
Exception: During live ball situations, when a player becomes injured and requires immediate attention, an umpire shall call time.
- F. An umpire shall not call time if requested by the offensive team after the pitcher has started the delivery.
- G. During live ball situations, when a player becomes injured and in the umpire's judgment, requires immediate attention, the umpire shall call "TIME" and award any bases that would have been reached.
- H. Umpires shall not suspend play at the request of players, coaches, or managers until all action in progress has been completed.

RULE 11 - SCORING

Failure of official scorer to adhere to Rule 11 shall not be grounds for protest. These are guidelines for the official scorer.

SECTION 1 - OFFICIAL SCORER

The official scorer shall keep records of each game as outlined in the following rules. The official scorer shall have sole authority to make all decisions involving judgment in relation to scorekeeping. For example, it is the scorer's responsibility to determine whether a batter-runner's advance to first base is the result of a hit or an error; however, a scorer shall not decide which conflicts with the official playing rules or with an umpire's decision.

SECTION 2 - THE BOX SCORE

- A. Each player's name and the position or positions played shall be listed in the order in which the player batted or would have batted had the player not been removed or had the game not ended before the player's turn at bat.
1. The designated player (DP) is optional, but if one is used it must be made known prior to the start of the game and listed on the score sheet in the regular batting order. Ten names will be listed, with the 10th name (or the last position in Junior Olympic Pool Play only) being the FLEX player, playing defense only. The FLEX player may bat only if they move into the DP position in the batting order.
 2. (Junior Olympic Fast Pitch Pool Play only) The extra player (EP) is optional, but if one is used it must be made known prior to the start of the game and be listed on the score sheet in the regular batting order.
- B. Each player's batting and fielding record must be tabulated.
1. The first column will show the number of times at bat by each player, but a time at bat will not be charged against the player when:
 - a. The player hits a sacrifice fly that scores a runner.
 - b. The player is awarded a base on balls.
 - c. (Fast Pitch) The player hits a sacrifice bunt.
 - d. (Fast Pitch) The player is hit by a pitched ball.
 - e. (Fast Pitch) The player hits a sacrifice slap hit.
Note: A slap hit is defined as a fake bunt followed by a controlled swing and resulting in the runner(s) advancing, as in the case of a sacrifice bunt.
 - f. The third out occurs and the batter is not entitled to run to first base.
 2. The second column will show the number of runs scored by each player.
 3. The third column will show the number of base hits made by each player. A base hit is a batted ball that permits the batter to reach base safely:
 - a. On a fair ball which settles on the ground, clears the fence, or strikes the fence before being touched by a fielder.
 - b. On a fair ball which is hit with such force or such slowness or which takes such an unnatural bounce that it is impossible to field with ordinary effort in time to make an out.
 - c. When a fair ball which has not been touched by a fielder becomes dead because of touching the person or clothing of the umpire.
 - d. When a fielder unsuccessfully attempts to retire a previous runner and in the scorer's judgment, the batter-runner would not have been retired at first base by perfect fielding.
 4. The fourth column will show the number of opponents put out by each player.
 - a. A put out is credited to a fielder each time they:
 - i. Catch a fly ball or line drive.
 - ii. Catch a thrown ball that retires a batter-runner or runner.
 - iii. Touch a runner with the ball when the runner is off the base to which the runner is entitled.
 - iv. Are nearest the ball when a runner is declared out for being struck by a fair batted ball or for interference with a fielder, or when a runner is called out for being in violation of Rule 8, Sections 7E, J, S or T.
 - v. Are the nearest fielder to an unreported substitute who is declared out in accordance with Rule 4, Section 6C [3]
 - b. A put out is credited to the catcher:
 - i. When a third strike is called.
 - ii. When the batter fails to bat in correct order.
 - iii. When the batter interferes with the catcher.
 5. The fifth column shall show the number of assists made by each player. An assist shall be credited:
 - a. To each player who handles the ball in any series of plays which results in the put out of a runner or batter-runner. One assist only shall be given to any player who handles the ball on any put out. The player who makes the put out in a rundown or similar type play shall be credited with both an assist and a put out.
 - b. To each player who handles or throws the ball in such a manner that a put out would have resulted except for an error of a teammate.
 - c. To each player who, by deflecting a batted ball, aids in a put out.
 - d. To each player who handles the ball on a play which results in a runner or batter-runner being called out for interference or for running out of the base path.
 6. The sixth column will show the number of errors made by each player. Errors are recorded:
 - a. For each player who commits a misplay which prolongs the turn at bat of the batter or extends the existence of the runner.
 - b. For the fielder who fails to touch a base after receiving a thrown ball to retire a runner on a force out, or when a runner is compelled to return to a base and provided the thrown ball could be caught by the fielder with ordinary effort.
 - c. For the catcher if a batter is awarded first base because of catcher obstruction.
 - d. For the fielder who fails to complete a double play because of a dropped ball.

- e. For a fielder if a runner advances a base because of that fielder's failure to catch, stop or try to stop a ball accurately thrown to a base, provided there was occasion for the throw. When more than one player could receive the throw, the scorer must determine which player should receive the error.

SECTION 3 - BASE HITS

A base hit shall not be scored:

- A. When a runner is forced out on a batted ball or would have been forced out except for a fielding error.
- B. When a player fielding a batted ball retires a preceding runner with ordinary effort.
- C. When a fielder fails to retire a preceding runner and, in the scorer's judgment, the batter-runner could have been retired at first base.
- D. When a batter reaches first base safely because of a preceding runner being called out for interfering with a batted or thrown ball, or with a defensive player.

SECTION 4 - RUNS BATTED

A run batted in is a run scored because of:

- A. A safe hit.
- B. A sacrifice bunt, a sacrifice slap hit, or a sacrifice fly.
- C. An infield put out or fielder's choice.
- D. A runner forced home because of obstruction, a hit batter, or a base on balls.
- E. A home run and all runs scored as a result.
- F. Subject to the provisions of Rule 11, Section 4G, when the batter ends a game with a safe hit which drives in as many runs as are necessary to put a team in the lead, the batter shall be credited with only as many bases on the hit as are advanced by the runner who scores the winning run, and then only if the batter runs out the hit for as many bases as are advanced by the runner who scores the winning run.
- G. The batter ends a game with a home run hit out of the playing field and all runners on base are entitled to score.

SECTION 5 - PITCHER CREDITS

A pitcher shall be credited with a win:

- A. When a starting pitcher has pitched at least four innings and the pitcher's team is not only in the lead when the pitcher is replaced but remains in the lead for the remainder of the game.
- B. When a starting pitcher has pitched at least three innings and the pitcher's team scores more runs than the opposing team in a game that is terminated after five innings of play, or in a game that is terminated after the pitcher's team has scored more runs in four or more innings than the opposing team has scored in five or more innings, and provided that the pitcher's team is not only in the lead if the pitcher is replaced after three innings of pitching but remains in the lead for the remainder of the game.

SECTION 6 - PITCHER LOSSES

A pitcher will be charged with a loss:

Regardless of the number of innings the pitcher has pitched, a pitcher shall be charged with a loss if replaced when the pitcher's team is behind in the score and fails to tie the score or gain the lead thereafter.

SECTION 7 - THE SUMMARY

The summary shall list the following items in this order:

- A. The score by innings and the final score.
- B. The runs batted in and by whom.
- C. Two-base hits and by whom.
- D. Three-base hits and by whom.
- E. Home runs and by whom.
- F. Sacrifice flies and by whom.
- G. Double plays and players participating in them.
- H. Triple plays and players participating in them.
- I. Number of bases on balls charged to each pitcher.
- J. Number of strike outs by each pitcher.
- K. Number of hits and runs allowed by each pitcher.
- L. The name of the winning pitcher.
- M. The name of the losing pitcher.
- N. The time of the game.
- O. The names of the umpires and scorers.
- P. Stolen bases and by whom. This includes a batter advancing to second base on an awarded base on balls.
- Q. (Fast Pitch Only) Sacrifice bunts and by whom.
- R. (Fast Pitch Only) The names of batters hit by a pitched ball and the names of the pitchers who hit them.
- S. (Fast Pitch Only) The number of wild pitches charged to each pitcher.
- T. (Fast Pitch Only) The number of passed balls charged to each catcher.

SECTION 8 - STOLEN BASES

A stolen base is credited to a runner whenever they advance one base unaided by a hit, put out, force out, fielder's choice, passed ball, wild pitch, an error, illegal pitch, or obstruction.

SECTION 9 - FORFEITED GAMES

All records of a forfeited game will be included in the official records except that of a pitcher's won-lost record.

SECTION 10 - TIE BREAKER RULE

In scoring, the run scored by the player starting as a runner at second base shall be charged to the defensive team and not the pitcher. Depending on the judgment of the official scorekeeper, a run scored by any other player will be charged to the pitcher's ERA.

RULE 12 - USE OF USA SOFTBALL PLAYING RULES

- A. USA Softball Playing Rules shall only apply to USA Softball Championship Play. Provided, however, in accordance with USA Softball Procedural Code, USA Softball Local Associations as well as other organizations may adopt or use all or any part of the USA Softball Playing Rules as they deem appropriate for use in Non-Championship Play. The use of all or any part of such rules is strictly a local matter, and such rules may be altered as league officials deem appropriate or necessary to conduct Non-Championship Play.
- B. Non-Championship Local League. USA Softball, as National Governing Body for Softball in the United States understands that local city or county leagues may adopt and use USA Softball's official playing rules. The use of any or all of USA Softball's playing rules is strictly a local matter and the rules may be altered as league officials deem necessary to conduct their own league play. USA Softball expressly disclaims all liability associated with the use of its official playing rules or any modification of its official playing rules, including its equipment standards, is to promote competitive balance and to preserve the integrity of the sport of amateur softball. USA Softball's official playing rules, or any modification thereof, should not be considered a guarantee that participants, spectators, or others will be safe or free from injury or harm. As stated in the preamble to the USA Softball Code, there are many risks and dangers incidental to the game of softball and USA Softball disclaims all liability associated with the game of softball or the use of its rules or Code. USA Softball does not review, sanction, or approve of any modifications to its official playing rules. To the extent USA Softball's official playing rules are modified by local leagues; such modification may increase the potential or likelihood of injury, death, or property loss, including the dangers associated with increased batted ball speeds. USA Softball shall not be responsible for any injury (including death) or property loss to any person in connection with any modification of USA Softball's official playing rules or the use of USA Softball's rules or any modified rules at any game or event.
- C. Use of USA Softball Official Playing Rules. USA Softball's official playing rules are designed to be used at USA Softball championship events and implemented by USA Softball officials and volunteers. USA Softball shall not be responsible for any injury (including death) or property loss to any person in connection with the use and implementation of USA Softball's official playing rules at any event, whether the event is recognized or sanctioned by USA Softball.

RULES SUPPLEMENT

1 - APPEALS

- A. Types.
1. Missing a base, forward or backward, or touching the white portion only of the double base when a play is being made on the batter-runner at first base. Exception: A play from foul territory, or an errant or missed throw pulling the defensive player into foul territory.
 2. Leaving a base on a caught fly ball before the ball is first touched.
 3. Attempting to advance to second base after making a turn at first base.
 4. Batting out of order.
- B. Live. In all games an appeal may be made during a live ball by any fielder in possession of the ball touching the base missed or left too soon on a caught fly ball, or by tagging the runner committing the violation if they are still on the playing field.
- C. Dead. The dead ball appeal may be made:
1. Once all runners have completed their advancement and time has been called. Runners must be given ample opportunity, in the umpire's judgment, to complete their base running responsibilities. Any coach or infielder, with or without the ball, may make a verbal appeal on a runner missing a base or leaving a base too soon on a caught fly ball. The pitcher and the catcher are considered infielders for the appeal process. The appropriate umpire should then decide on the play.
 2. When a ball goes out of play, runners must be given the opportunity to complete their base running responsibilities before the dead ball appeal can be made.
- D. May Not Return. A runner may not return to touch a base missed or one left too soon on a caught fly ball if:
1. They have left the field of play.
 2. A following runner has scored.
 3. Once a runner advances to and passes the next base awarded.
Note: A "dead ball" should be called, and runners given the opportunity to complete their base running responsibilities. Returning to touch a base missed or one left too soon must occur prior to an award; therefore, on an overthrow the umpire should hesitate in making the award while watching what the runner does. If the runner shows no intention of returning to touch a base missed or re-tag a base left too soon, then the umpire should make the award. Once the umpire awards bases, and if a runner reaches the first base of the award, and then for any reason retreats to a previous base missed or left too soon, this is an illegal act. The defense may appeal, and the umpire should rule the runner out.
- E. When appeals must be made:
1. Before the next pitch, legal or illegal.
 2. At the end of an inning, before the pitcher and all infielders have left fair territory on their way to the bench or dugout area.
 3. On the last play of the game, an appeal can be made until the umpires leave the field of play.

- F. Advance. Runners may advance during a live ball appeal. When the ball is live in fast pitch, each runner may leave their base when:
1. The pitcher no longer has possession of the ball within the pitcher's circle.
 2. The pitcher makes a play on any runner; a fake throwing motion is considered a play. If time out is requested for an appeal, the umpire should grant time and runners may not advance until the next pitch.
- G. More Than One Appeal. More than one appeal play may be made but guessing should not be allowed.
- Example:** The runner misses second base by a step, but just touches the corner of third base. Even though an appeal is made at third base and the umpire called the runner safe, an appeal may be made at second base on the same runner.
- H. Awards. An appeal should be honored even if the base missed was before or after an award.
- I. Plate and Tag Missed. If a runner misses home plate and the catcher misses the tag, the umpire should hesitate slightly. If no tag is made, the umpire should call the runner safe. If an appeal play is made by tagging the runner or home plate, the umpire should then render a decision.
- J. Force Out. When an appeal is the third out and a force out, no runs shall score. The force is reinstated when a forced runner retreats toward the base first occupied and they may be put out if the defense tags the runner or the base to which they are forced. When the batter-runner is put out prior to reaching first base, all force outs are eliminated. On an appeal play, the force out is determined when the appeal is made, not when the infraction occurred. Therefore, if the batter-runner or trail runner is put out prior to an appeal, the out on the appeal will not be considered a force out.
- K. Tag-Ups. When a runner leaves a base too soon on a caught fly ball and returns to retouch, this is considered a time play and not a force out. When the appeal is the third out, all runs scored in advance of the appealed runner and prior to the legal appeal count.
- L. Missing First Base Before the Throw Arrives. When a runner passes first base before the throw arrives, they are considered to have touched the base unless properly appealed. On appeals involving the double base, when the batter-runner touches the white rather than the contrasting color portion and a play is made, the same procedure applies. When an appeal is made in both situations, it must be made prior to the runner returning to first base while the ball is live.
- Exception:** If a play is being made from first base foul territory, or an errant or missed throw pulls the defensive player into foul territory, the runner may touch the white or contrasting color portion of the base. This is not considered missing the base.
- M. Fourth-Out Appeal. An appeal may be made after the third out of an inning if it is made properly. The appeal must be made on a runner who has scored but missed a base or left a base too soon. **EXAMPLE:** One out with runners on first and third base. The batter hits a fly ball that is caught. Both runners leave their base before the caught ball is touched. An appeal is made at first base for the third out. The defense then makes an

appeal at third base before all infielders leave the infield. The runner on third base should be called out, and the run does not count.

- N. End of Game. When a situation arises that could lead to an appeal by the defense on the last play of the game, umpires should wait until all infielders have crossed the foul line on their way to the dugout before leaving the infield. If teams line up for "high-fives" there is little chance for an appeal even if the infielders have not crossed the foul line. Umpires should leave the field at this time. No appeal can be made once the umpires leave the field.

2 - BALL ROTATION PROCEDURE

Many local associations now use the same ball rotation procedure that is used in championship play. The procedure is as follows:

- A. The pitcher has a choice of which ball to use at the start of each half inning. However, if both balls do not get into play in the first half of the first inning, the pitcher in the bottom half of the first inning **MUST** throw the unused ball. No choice is offered.
- B. The current game ball should be used until it goes out of play or becomes unplayable. When the ball goes out of play, the umpire should put another ball in play. The pitcher now **MUST** pitch with that ball unless the ball is deemed unplayable by the umpire.
- C. If the pitcher requests another ball because it is unplayable, give them another ball and remove the unplayable ball from the game. Do **NOT** give the pitcher a choice of balls when nothing is wrong with the ball.
- D. After an inning is completed, the ball should be returned to the vicinity of the pitcher's plate by the team leaving the field. The pitcher taking the field now has a ball with which to start the next half inning. The pitcher may request another ball from the plate umpire, and the umpire should give them another ball after receiving the ball from the pitcher. The pitcher has now made their choice and must pitch that ball.

3 - BAT WITH DENTS, RATTLES, EXCESSIVE WEAR OR DELAMINATIONS. COMPRESSION TESTING PSI REQUIREMENTS

When bats with dents, excessive wear or a rattle are found, that bat shall be removed and held until the Championship is over. When noticeable delamination appears on the Easton style bats designed to show delamination on the barrel area more than an inch in any direction, remove that bat and hold it until the end of the Championship.

Approved bats shall not be rolled, shaved, or modified to change their characteristics from that produced by the manufacturer and shall be considered an altered bat.

- A. All bats used at National Championships are required to be compression tested.
 1. Bats used in games:
 - a. If they bear the 2000, 2004 or the new USA Softball Approved Certification Mark must meet or exceed the compression threshold of 1550 PSI.
 - b. If they bear the 2013 or new USA Softball Approved Certification Mark it must meet or exceed the compression threshold of 1450 PSI.

2. A non-linear bat, a bat whose structure deviates from the traditional design, must meet or exceed the compression thresholds that are listed for that make and model on the USA Softball website under certified equipment, Non-Linear Bat Compression Thresholds for divisions of play.

4 - BATTING WITH AN ILLEGAL, ALTERED, OR NON-APPROVED BAT

When a batter uses an illegal, altered, or non-approved bat and reaches base safely, and the next batter steps into the batter's box with the same bat, the following penalty is in effect:

- A. If noticed before a pitch is thrown to the next batter, the umpire should call out the batter who used the bat and is now on base.
- B. If the bat is altered or non-approved, the player is ejected from the game and subject to future penalties by the tournament protest committee. The bat is removed from the game, runners put out prior to discovering this infraction remain out, and runners not put out return to the base they occupied at the time of the batted ball.
- C. After a pitch to the current batter, that batter is called out and there is no penalty to the previous batter for using the illegal or altered bat.

5 - BATTER REMAINS IN BATTER'S BOX

This rule is not intended to penalize the player but is used to speed up the game. The batter can still get a signal with one foot in the box and take practice swings.

If the batter leaves the box illegally, a warning should be given. Any number of warnings on the same batter may be given. A strike should not be called without a warning. One, two or three strikes may be called on the same batter under this ruling.

6 - BATTING ORDER IS OFFICIAL

The batting order is considered official when it is reviewed by the manager and the plate umpire at the Pre-Game Meeting. Once the manager approves the line-up and returns it to the umpire, any changes thereafter are considered a substitution.

7 - BATTING OUT OF THE BATTER'S BOX

To call a batter out for batting out of the batter's box, one foot or both feet must be on the ground completely outside the lines of the batter's box when contact is made with the ball. The lines of the batter's box are considered inside the batter's box.

A batter should be called out immediately for hitting a pitched ball while out of the batter's box, or for re-entering the batter's box and contacting the ball. The ball is dead, and the batter is out whether the ball is fair or foul. When there are no batter's box lines, good judgment should be used, and the benefit of doubt should go to the batter. If contact is not made with the ball, there is no penalty.

8 - CATCHER'S BOX

The catcher's box is described in Rule 2, Section 3D.

Catchers must remain in the catcher's box until the pitch is released. The catcher may move closer to the plate without penalty when the batter is positioned in the front portion of the batter's box during a pitch. However, the catcher must, always, still avoid catcher's obstruction as the batter has the right to the entire batter's box.

Obstruction does not require contact between the catcher and the bat or the batter. The umpire's request for the catcher to move farther away from the batter to avoid injury or obstruction should be obeyed. (See catcher obstruction under Rules Supplement number 34.)

9 - CHARGED CONFERENCES

- A. Defensive. A defensive charged conference occurs when the defense requests a suspension of play for any reason, and a representative enters the playing field to communicate with any defensive player. Should a defensive player approach the dugout and receive instructions, this is considered a defensive conference. The umpire should advise a team representative when a defensive conference has been charged. A TEAM IS ALLOWED THREE CONFERENCES PER SEVEN INNINGS. It is not a charged conference if the pitcher is removed. They may use all three conferences in one inning or spread them out over a seven-inning game. Once the three conferences have been used, the pitcher must be removed for each additional charged conference. In extra-inning games, there will be one charged conference allowed in each extra inning. On the second conference in an extra inning of a game, the pitcher must be removed. If the pitcher returns to the pitching position after being removed and one pitch is thrown, the pitcher is disqualified.
- B. Offensive. An offensive charged conference occurs when the offensive team requests a suspension of play and is granted time by an umpire to permit a team representative to confer with a batter, a runner(s), or another team representative. Only one such conference is allowed per inning. The umpires should refuse to grant the second conference.
Effect: If the offensive team insists on holding a second conference in an inning after being informed by the umpire that it is not permitted, the umpire should eject the team representative from the game. It is not an offensive conference when a team representative confers with a batter and / or runner(s) during a defensive charged conference if they are ready to play when the defense is ready, or when the pitcher is putting on a warm-up jacket.
- C. Umpires. A conference should not be charged to either team when time-out is called by the umpire for a legitimate reason. EXAMPLE: An injured player, blood rule, scorekeeper problems, field maintenance repairs, etc. A coach may confer with a pitcher, batter, or a runner during an umpire's time-out without penalty, if they are ready to continue once the problem is resolved.

10 - CHECK SWING/BUNT STRIKE

Normally, there are four areas which could constitute whether a batter swung at the pitched ball or checked their swing.

- A. Did the batter roll their wrists?
- B. Did the batter swing through the ball and bring back the bat, unless the batter draws the bat back before the pitch arrives?
- C. Was the bat out in front of the body?
- D. Did the batter try to hit the pitch?

On a bunt attempt where the batter puts the bat across the plate and the pitched ball is out of the strike zone, a ball should be called unless the batter moves the bat toward the ball. In each of the above situations, the umpire should think in terms of priorities. First, was the pitch in the strike zone? If so, it is simply a strike. Second, did the batter swing at the pitched ball, or, in the case of a bunt attempt, did the batter move the bat toward the pitched ball? In either case, it is the plate umpire's call. If in doubt, or if blocked out, the umpire should call the pitch a ball. If the umpire calls the pitch a ball and the catcher request the umpire to go for help, the plate umpire should ONLY ask for help if there is doubt in their mind as to whether the batter swung at the pitched ball. On a missed bunt attempt with two strikes, the dropped third strike rule applies. (Rule 8, Section 1B)

11 - COMMUNICATION / ELECTRONIC DEVICES

Communication / electronic devices, including audio / video equipment, are not allowed on the playing field. Headphones and earphones have been used by coaches to communicate from one coaches' box to the other, to communicate between coaches and the dugout, and from the stands to the dugout. Signs and signals have been stolen while outside the field of play, stands or the outfield area and communicated to coaches or players. Therefore, umpires must prohibit any use of such equipment. Electronic scorebooks, however, are permitted for use by base coaches.

12 - COURTESY RUNNER

The Courtesy Runner is a part of Fast Pitch.

- A. Only players who have not been used in the game can be used as a courtesy runner, but only for the pitcher and catcher. Exception: J.O. Pool Play Only, any player can be a courtesy runner.
- B. Any player may use a courtesy runner once they reach base. Any player may be used for the ADA player. A courtesy runner not reported is disqualified when brought to the umpire's attention by the offended team. See Rule 8, Sections 9 and 10 for other guidelines to follow.

13 - CRASHING INTO A FIELDER WITH THE BALL (Interference)

To prevent injury and protect a defensive player attempting to make a play on a runner, a runner must be called out when they remain on their feet and crash into a defensive player who is holding the ball and waiting to apply a tag. To prevent the out ruling, the runner may slide, jump over the defender holding the ball, go around the defender or return to the previous base touched. If the act is determined to be flagrant, the offender is ejected. A runner may slide into the fielder.

- A. When a runner is called out for crashing into a fielder holding the ball, the ball becomes dead. Each runner must return to the last base touched at the time of the crash as this constitutes interference.
- B. When, as in A above, the runner crashes into a fielder holding the ball before being put out and, in the judgment of the umpire, it was an attempt to break up an obvious double play, the immediate succeeding runner is also called out. (Rule 8, Section 7J)
- C. When a crash occurs after the runner is called out, the runner closest to home plate is also out. (Rule 8, Section 7P)
- D. When an obstructed runner crashes into a fielder holding the ball, the obstruction is ignored, and the runner is out. (Rule 8, Section 7Q) This type of award, Rule 8, Section 5B [2 & 3], does not give the runner the right to violate Rule 8, Section 7Q.
- E. When a runner runs outside the three-foot lane to avoid a crash with a defender holding the ball and waiting to apply a tag, the runner should be called out.
- F. When a defensive player is fielding a thrown ball and the flight of the ball carries or draws them into the path of the base runner, it is not a crash.

14 - DELAYED DEAD BALL

There are five situations in which a violation of a rule occurs, the umpire recognizes the violation, but the ball remains live until the conclusion of play. These situations are:

- A. An illegal pitch. (Rule 6, Section 1-8 Fast Pitch)
- B. Catcher's obstruction. (Rule 8, Section 1D)
- C. Plate umpire interference. (Rule 8, Section 6F)
- D. Obstruction. (Rule 8, Section 5B)
- E. Batted or thrown ball contacts detached equipment. (Rule 8, Section 5F)

In each situation, once the play is completed, the proper enforcement should be made.

15 - DESIGNATED PLAYER OR DP

The designated player may be listed in any of the nine batting positions in the batting order. The player listed tenth in the batting order plays defense for the DP, but may also play offense for the DP, and is called the FLEX.

- A. A designated player (DP) may be used for any defensive player provided it is made known to the plate umpire prior to the start of the game. The DP must be indicated on the line-up card as one of the nine hitters in the batting order.
- B. The name of the player for whom the DP is batting, FLEX, must be placed in the tenth position on the line-up card.
- C. The DP and any substitutes for the DP must remain in the same position in the batting order throughout the game. The FLEX and all substitutes for the FLEX must enter the game in the tenth position in the line-up card.
- D. The DP may be substituted for at any time by a pinch hitter or pinch runner. The substitute becomes the DP and has all the options of the DP position. The starting DP and a substitute for the DP may not be in the game at the same time.

- E. The FLEX may be substituted for at any time. The substitute becomes the FLEX and has all the options of the FLEX position. The starting FLEX and a substitute for the FLEX may not be in the game at the same time.
- F. The starting DP and their substitute may be replaced by the FLEX as a hitter or as a runner. This reduces the number of players in the game from ten to nine. The DP and the FLEX may not be on offense at the same time.
- G. The FLEX may be replaced on defense by the DP. This reduces the number of players in the game from ten to nine. The DP and the FLEX may be on defense at the same time.
- H. The starting DP may re-enter the game one time, but only in the original DP position in the batting order. If the DP re-enters and the FLEX is batting in the DP position, the FLEX must:
 - 1. Return to the number ten position in the line-up and play defense only. This is not considered to have left the game. Or,
 - 2. Leave the game.
- I. The starting FLEX may re-enter the game one time and must:
 - 1. Return to the original FLEX position, tenth in the line-up card, or
 - 2. Take the place of the starting DP in the batting order. If the FLEX re-enters and the DP is playing defense in the FLEX position, the DP must continue to bat in the DP position in the batting order, play offense only or play defense for another player. This is not considered to have left the game.
- J. The DP may play defense for any player and at any position. Should the DP play defense for a player other than the FLEX, that position player continues to bat and does not play defense. That player is not considered to have left the game.
- K. The role of the DP / FLEX is never terminated. A team may go from ten to nine players and back to ten players any number of times during the game. The game may end with ten or nine players.
- L. If the DP replaces the FLEX, or the FLEX replaces the DP, the change must be reported to the umpire. If not reported, the change is treated the same as an unreported substitute.

16 - DUGOUT CONDUCT

This rule reflects on all game participants. Once the game begins, only players involved in the game may be outside the dugout, except when the rule allows, or the reason is justified by an umpire. A manager walking on the field for a conference is an example of a rule allowing a coach or player on the field. An example of umpire justification is when a game participant must leave the dugout to go to the restroom. Except for the on-deck batter, players may not be out of the dugout between innings standing near the batter's box observing the pitcher warming up, nor should game participants be allowed to step outside the dugout to observe the game from behind the backstop. Participants may not smoke or use alcoholic beverages inside the dugout or on the playing field.

17 - EQUIPMENT ON THE PLAYING FIELD

Loose equipment, miscellaneous items, or a detached part of a player's uniform, other than that being legally used in the game at the time, should not be within live ball territory.

Official equipment which may be in live ball territory with no penalty includes the batter's bat, the catcher's mask, umpire paraphernalia, a helmet which has inadvertently fallen off an offensive or defensive player during play or any equipment belonging to a person assigned to the game. Loose equipment, miscellaneous items or detached uniform parts which are in live ball territory and are not being legally used in the game at the time could cause a blocked ball or interference.

- A. Thrown Ball.
 - 1. When a thrown ball hits loose equipment belonging to the team at bat, the ball is dead immediately. If such action interferes with a play, interference should be ruled. The runner being played on at the time of the interference is called out, and each runner must return to the last base touched prior to the interference. If a play is not apparent, a blocked ball should be ruled, no one is called out, and all runners must return to the last base touched at the time of the dead ball.
 - 2. When the loose equipment belongs to the team in the field, it becomes a blocked ball, and the overthrow rule applies.
- B. Batted Ball.
 - 1. A batted foul ball touching loose equipment is a foul ball.
 - 2. A batted fair ball touching loose equipment belonging to:
 - a. The offense, it is a dead ball and runners return, unless they are forced to advance when the batter-runner is awarded first base on a base hit, or
 - b. The defense, it is a dead ball and all runners, including the batter-runner, are awarded two bases from their position at the time of the pitch.

18 - EXTRA PLAYER OR EP (Pool Play)

If a team uses the EP, it must be indicated on the line-up card at the start of the game. The team must end the game with 11 players or play using the shorthanded rule.

All 11 players bat, but only ten play defense. Defensive changes may be made at any time; however, the batting order may not change. EXAMPLE: The EP may sit on the bench one inning, play third base one inning, play the outfield one inning, sit on the bench again and then play first base. All these defensive changes are legal if the EP remains in the same position in the batting order. This applies to the starting 11 players.

Any of the 11 starting players may leave the game once and re-enter. A starting player and their substitute may not be in the game at the same time. If this occurs, the player listed in the wrong position in the batting order is disqualified.

Pool Play Only: Any batters in addition to the defensive players and / or DP/FLEX shall be listed as EP's. Defensive changes may be made at any time; however, the batting order may not change.

19 - FAKE TAG

A fake tag occurs when a fielder without the ball deceives the runner by impeding their progress; for example, causing a runner to slide, slow down or stop running.

- A. Obstruction is called when a fake tag is made as mentioned above. The umpire should signal delayed dead ball and let the play continue to its completion. The obstructed runner, and each runner affected by the obstruction, should always be awarded the base, or bases they would have reached had the obstruction not occurred. Again, each runner is awarded only the base or bases that in the judgment of the umpire they would have reached had there not been obstruction.
- B. The umpire should rule obstruction on all fake tags. Continued fake tags should result in ejections. In flagrant cases where the sliding player gets hurt, the offending player should be ejected without warning.
- C. When a fielder fakes a tag, but the runner continues to the next base without sliding or breaking stride, there is no rule violation since the runner's progress was not impeded. However, a warning should be given.

20 - FALLING OVER THE FENCE ON A CATCH

The fence is an extension of the playing field, which makes it legal for a player to climb the fence and make the catch. When a player catches a ball in the air and their momentum carries them through or over the fence, the catch is legal, the batter-runner is out, the ball is dead, and with fewer than two outs all runners are advanced one base without liability to be put out. Guidelines are as follows:

- A. When a player catches the ball before they touch the ground outside the playing area, the catch is legal, or
- B. When a player catches the ball after they touch the ground outside the playing area, it is not a catch. When a collapsible, portable fence is used and a defensive player is standing on the fence when the catch is made, it is a legal catch. A defensive player may climb a fence to make a legal catch; therefore, a defensive player may also stand on a fence that has fallen or is falling to the ground. If the defensive player has not stepped outside the playing area, the other side of fence, the catch is legal.

21 - FORCE OUT

A force out can be made by tagging a runner who is forced to advance to a base as the result of the batter becoming a batter-runner, or by touching the base to which they are being forced. It is not possible to have a force out on a caught fly ball as the batter-runner is no longer a runner. On an appeal play, the force out is determined at the time the appeal is made, not when the infraction occurred.

22 - FOUL BALL/FOUL TIP

The reference of the "height of the batter's head" as it relates to a Foul Ball and Foul Tip no longer applies. This change, instituted in 2006, allows more opportunity for the catcher to obtain "outs" by catching foul batted balls the same as any other fielder who is playing closer

to home plate. Umpires only need to judge whether the ball moves from the bat "sharply" and "directly" versus a ball that has a perceptible arc and if the catcher moves their glove/mitt to catch the ball after contact with the bat.

The definition of a foul ball has not changed. However, a foul tip is now defined as a batted ball that goes sharply and directly from the bat to the catcher's glove/mitt or hand and is legally caught by the catcher. It is not a foul tip unless caught and any foul tip that is caught is a strike, and the ball remains live. It is not a catch if the ball rebounds off the catcher unless the ball has first touched the catcher's glove/mitt or hand. Again, a foul tip can only be caught by the catcher. Examples of foul ball and foul tip follow:

- A. A foul ball with "perceptible" arc goes toward the catcher's left and the catcher moves their glove/mitt to catch the ball. In this situation, the batter is out, and the ball remains live just as it would when any other fielder catches a foul fly ball.
- B. The foul ball rebounds from the bat with a "perceptible arc" shoulder high and the catcher moves upward with the glove/mitt to make the catch. In this situation, the batter is out, and the ball remains live just as it would when any other fielder catches a foul fly ball.
- C. The pitcher throws a rise ball, and the catcher is moving up as the pitch is on the way to home plate. The batter squares to bunt the ball above their head and the ball goes in a straight line from the bat to the glove/mitt and the catcher catches the ball. In this situation, it is a foul tip. It does not matter that the ball is above the batter's head. The only thing that matters when determining whether it is a foul tip is the fact that the ball goes directly from the bat to the catcher's glove/mitt or hand and then is caught by the catcher.

Umpires must be alert to the fact that runners need to tag-up on a batted foul ball that is caught. This increases the opportunity for more "outs", not only with the catcher catching the ball but the opportunity for more appeal plays with a runner leaving a base too soon on a caught fly ball. Remember, the runner must wait until "first touch" before breaking contact with a base on a caught fly ball, fair or foul. Runners may leave when the pitch is released.

23 - GLOVE/MITT (Using an Illegal Glove/Mitt)

If discovered or brought to the umpire's attention, it should be corrected immediately. If a player refuses to correct the use of an illegal glove/mitt, they may not play.

24 - HITTING THE BALL A SECOND TIME

When considering the act of a batter hitting the pitched ball a second time, umpires should place the act into one of three categories.

- A. If the bat is in the hands of the batter when the ball contacts the bat, and the batter is in the batter's box, it is a foul ball. If, when the bat contacts the ball a batter's entire foot is completely outside the batter's box, the batter is out. When in doubt, do not guess the batter out. Call a foul ball.

- B. If the bat is out of the batter's hands, dropped or thrown, and it hits the ball a second time in fair territory, the ball is dead, and the batter-runner is out. However, if the BALL hits the bat on the ground, the batter is not out, and the umpire must then determine whether the ball is fair, or foul based on the fair / foul rule. If the ball rolls against the bat in fair territory, the ball remains live. If the ball stops or is touched in fair territory, it is a fair ball. If the ball touches the bat in fair territory and then rolls to foul ground and stops, it is a foul ball. If the ball rolls against the bat in foul territory, it is a foul ball.
- C. If a batter swings at and misses the pitched ball but:
 1. Accidentally hits it on the follow-through, or
 2. Intentionally hits it on the second swing, or
 3. Hits the ball after it bounces off the catcher or mitt/glove.

The ball is dead, and all runners must return to the base they occupied prior to the pitch. In (2) and (3), if the act is intentional with runners on base, the batter is called out for interference. If this occurs on strike three in fast pitch, Rule 8, Section 2F has precedence.

25 - HOME RUNS/FOUR BASE AWARDS/TWO BASE AWARDS

When a ball does not hit the ground and leaves the playing field in fair territory, it is a home run.

- A. A batted ball hitting a foul pole above the fence is a home run.
- B. A batted ball hitting the top of the fence and bouncing over in fair territory is a home run.
- C. A batted ball hitting a defensive player in fair territory but going over the fence in foul territory is a two-base award.
- D. A batted ball that leaves the park in fair territory and first touches the ground in foul territory is a home run.
- E. A batted ball that touches the fence, then touches a player and goes over the fence in fair territory is a two-base award.

26 - IMAGINARY LINE OR DEAD BALL AREA

When a fielder carries a live ball into a dead ball area, the ball becomes dead, and a base or bases are awarded to all runners. If the act is unintentional, the award is one base. If the act is intentional, the award is two bases. The base award is governed from the last base legally touched at the time the ball became dead.

When a chalk line is used to determine an out-of-play area, the line is in play. If a fielder is touching the line, the fielder is in the field of play and may make a legal catch or throw. If a foot is on the ground completely in dead ball territory, not touching the line, the ball becomes dead, and a play may not be made.

When a player has one foot inside the line or touching the line, and another foot in the air at the time the catch is made, the catch is legal, and the batter is out. If the fielder then steps into a dead ball area, foot on the ground, the ball becomes dead, and all runners are

awarded one base from the last base touched when the ball became dead. Defensive players cannot take advantage and intentionally throw or step into a dead ball area to prevent a runner who has missed a base or left a base too soon from returning to the base. If it is ruled that the defensive player intentionally threw the ball or stepped into the dead ball area, allow the runner to return to the base.

27 - INFIELDER

An infielder, pitcher, or catcher for purposes of an appeal play or the infield fly rule is any player who defends the area of the field around first, second, third or shortstop areas.

28 - INJURED PLAYER

During any live ball, when a player becomes injured and, in the umpire's judgment, requires immediate attention, the umpire should call time and allow first aid treatment. If runners are on base when time out is called, those runners should be awarded the bases that the umpire judges they would have reached if time out not been called.

29 - INTENTIONALLY DROPPED BALL

The ball cannot be intentionally dropped unless the fielder has caught it, and then drops it. Merely guiding the ball to the ground is not an intentionally dropped ball.

30 - INTENTIONAL WALK

The ball is live during an intentional walk. All defensive players must be in fair territory until the pitch is released, except the catcher who must remain in the catcher's box and the pitcher who must be in a legal pitching position at the start of each pitch. If the defensive players do not position themselves in fair territory, an illegal pitch should be called each time a pitch is made while a member of the defense is standing in foul territory. All four pitches must be thrown to the catcher.

31 - INTERFERENCE

Interference is the act of an offensive player or team member that impedes, hinders, or confuses a defensive player attempting to execute a play. Interference may be in the form of physical contact, verbal distraction, visual distraction, or any type of distraction that hinders a fielder in the execution of a play. Defensive players must be given the opportunity to field the ball anywhere on the playing field or throw the ball without being hindered.

- A. Runner interference includes:
 1. A runner or batter-runner who interferes with a fielder executing a play, including the batter-runner touching the white portion of the double base at first base and colliding with the fielder trying to catch a thrown ball from a fielder,
 - a. When a runner interferes with a fielder, the umpire must determine if the interference occurred before or after the runner who interfered was put out and then apply the appropriate rule.
 - b. When a runner is hit by a fair batted ball, it is interference if it occurred before the ball passed an infielder, excluding the pitcher, and provided the runner

was not in contact with the base. It is interference if the batted ball deflects off one defensive player and the runner intentionally interferes with any defensive player who has an opportunity to make an out.

- c. A runner could be standing on a base and a defensive player bumps the runner while watching the flight of the ball. If the defensive player fails to make a catch on a ball that could have been caught, it is the umpire's judgment whether interference should be called. The rule provides that a runner must vacate any space needed by a fielder to make a play on a batted ball unless the runner has contact with a legally occupied base when the hindrance occurs. In this case, the runner should not be called out unless the hindrance is intentional.
 - d. If interference occurs by the runner on a foul fly ball not caught but, in the umpire's judgment, could have been caught with ordinary effort had interference not occurred, the runner is out, and the batter is also out. If, in the judgment of the umpire, the foul fly ball could not have been caught with ordinary effort, a strike is called, the ball is dead, and the batter remains at bat.
 - e. For crash interference, refer to Rules Supplement number 13.
2. A runner or batter-runner who is hit by a fair touched or untouched batted ball, or
 3. Interfering with a thrown ball.
- B. Batter interference occurs while the batter is at bat and before the ball is batted. It occurs in fast pitch when the batter interferes with the catcher's throw on an attempted steal or when the batter interferes with the catcher on a play at the plate. The batter's box is not a sanctuary for the batter when a play is being made at the plate. Interference could also occur when a batter releases the bat in a manner that it hits the catcher and prevents them from making a play. If the batter merely drops the bat and the catcher trips over it, there is no interference. Batter interference is also discussed in RS #24B.
- C. Offensive players in the dugout may be charged with interference if they interfere with a fielder's opportunity to make an out on a fly ball.
- D. On-deck batters may be charged with interference if they interfere with a throw, a possible tag on a runner, or a fielder's opportunity to make an out on a fly ball.
- E. Coach's interference occurs when a base coach runs toward home and draws a throw or when they interfere with a fielder attempting to catch or throw a ball. The coach's box is not a sanctuary.
- F. Spectator interference occurs when a spectator:
1. Enters the field and interferes with a play.
Effect: The batter and runner(s) should be placed at the bases that they would have reached had spectator interference not occurred. The field belongs to the fielder and the stands belong to the spectator. Or
 2. Reaches onto the field from the stands and prevents a fielder from catching a fly ball in the field of play.

Effect: A dead ball is ruled, and the batter is out. All runners should be placed at the bases they would have reached had the interference not occurred. It is not interference if the fielder reaches into the stands.

- G. Umpire interference occurs:
1. When an umpire is hit by a fair, untouched batted ball before it passes an infielder, excluding the pitcher. The batter-runner is awarded first base. This is an exception to the statement that someone must be called out on interference.
 2. When an umpire interferes with a catcher's attempt to put out a runner stealing, or an attempted pick-off from the catcher to any base. It is interference only if the runner is not put out; in which case runners are returned to the base they occupied at the time of the pitch. Umpire interference may not be called in any other case. When batter, batter-runner, runner, on-deck batter, or coach interference occurs, the ball is dead, someone must be called out, and each other runner must return to the last base touched at the time of the interference.
- H. Offensive team interference occurs when a thrown ball strikes loose equipment left in live ball territory; but only when play is affected (RS #17).
- I. Batter-Runner interference occurs when the batter-runner steps back while running to first base to avoid a tag by a defensive player, or when running to first base, runs outside the three-foot lane over fair or foul territory and interferes with a thrown ball to first base.

32 - LOOK BACK RULE

When a runner is legitimately off base after a pitch, or because of a batter completing their turn at bat and is stationary when the pitcher has the ball in the circle, the runner **MUST** immediately attempt to advance to the next base or immediately return to the base left. The responsibility is entirely on the runner. There is no obligation on the pitcher to look, fake or throw.

- A. The Look Back rule does not go into effect for any runner until the batter-runner touches first base or is called out, and the pitcher has control of the ball within the eight-foot radius circle.
- B. Failure to immediately proceed to the next base or return to their original base after the pitcher has the ball within the circle results in the runner being called out.
- C. Once the runner returns or stops at any base for any reason, the runner is out if they leave that base.

Exception B-C: A runner will not be declared out when:

1. A play is made on another runner, or
2. The pitcher leaves the circle or drops the ball, or
3. The pitcher releases the ball to the batter, or
4. The pitcher places the ball under their arm or between their legs to free both hands to fix their uniform, hair, etc. The ball is not controlled unless it is held in the glove or hand. Once the pitcher controls the ball again in the glove or hand, the Look Back rule is again in effect.

- D. If multiple runners are off base and more than one umpire calls a runner out, the umpires must determine which runner was called out first and return the other runner(s) to the base they left. When a runner is declared out in this situation, the ball is dead. It is impossible to call two outs on the Look Back rule.
- E. A pitcher fielding a ball in the circle is an infielder and runners can leave their base. If runners leave their base, the same rule applies while the pitcher holds the ball in the circle: once the runner stops, they must decide which way to continue or be called out.
- F. A base on balls or a dropped third strike is treated as a batted ball if the batter-runner continues past first base without stopping or stops only once and then immediately moves one way or the other. However, if the runner stops at first base and then steps off the base after the pitcher has the ball in the circle, the runner is out.
- G. Batter-runners overrunning first base cannot start back to the base and before reaching first, advance to second base. If a batter-runner commits to first base, moving toward first base, the runner must return to that base. The batter-runner may not change their mind and advance to second base once they have started moving directly to first base following the overrun. If they do so, the runner is out. Umpire's judgment determines what is committing toward a base.
- H. If a runner is moving toward a base, other than first base, when the pitcher receives the ball in the circle, that runner may stop once then immediately advance to the next base or return to the previous base. A runner failing to advance to the next base or return to the previous base should be called out. Trying or faking justifies the runner being called out. If, after the pitcher has the ball in the circle, the runner starts back to their original base or forward to another base and then stops or reverses direction, the runner is out unless the pitcher makes a play on them or another runner. When a play is made on any runner, other runners may also stop or reverse their direction.
- I. A runner is out when standing off the base and they do not immediately attempt to advance or return after the pitcher has the ball in the circle.
- J. While in the circle and in possession of the ball, any act by the pitcher that, in the umpire's judgment, causes the runner to react is considered making a play.
- K. The pitcher must have control of the ball while in the circle. Placing the ball on the ground, holding the ball between their legs or under their arm is not considered having control of the ball.
- L. Being in the eight-foot circle is defined as both feet within and partially within the lines. The pitcher is not considered in the circle if either foot is completely outside the lines.

33 - MEDIA COVERAGE

Media authorized by the tournament committee can be on the playing field. All media personnel must be able to move to avoid being hit by an errant throw or by a batted ball. Should the media accidentally be hit, the ball remains live. All photographic equipment must be carried or on the photographer. No equipment can be left on the ground, including tripods. Should an errant throw or batted ball become lodged in the photographer's equipment, the overthrow or out of play rule applies.

34 - OBSTRUCTION

Obstruction is the act of a fielder:

- A. Not in possession of the ball, or
- B. Not in the act of fielding a batted ball, which impedes the progress of a batter-runner or runner who is legally running the bases.

It is obstruction if a defensive player is blocking the base or base path without the ball and the runner or batter-runner is impeded. In past years, coaches taught their players to block the base, catch the ball and make the tag. Now defensive players must catch the ball, block the base, and then make the tag.

Whenever obstruction occurs, whether a play is being made on a runner, the umpire should declare obstruction and signal a delayed dead ball. The ball remains live. If the obstructed runner is put out prior to reaching the base they would have reached had obstruction not occurred, a dead ball is called and the obstructed runner, and all other runners affected by the obstruction, shall be awarded the base(s) they would have reached, in the umpire's judgment, had obstruction not occurred. An obstructed runner may be called out between the two bases the runner was obstructed if the runner is properly appealed for missing a base or leaving a base before a fly ball is first touched. If the runner committed an act of interference after the obstruction or passed another runner, this also would overrule the obstruction.

When an obstructed runner is awarded a base that they would have reached had obstruction not occurred and a preceding runner is on that base, the obstructed runner shall be awarded that base and the runner occupying it is entitled to the next base without liability to be put out.

When an obstructed runner safely obtains the base, they would have been awarded, in the umpire's judgment, had obstruction not occurred and there is a subsequent play on a different runner, the obstructed runner is no longer protected between the two bases where they were obstructed. That runner may now be put out anywhere on the base paths.

It should also be clear that the statement "a runner cannot be called out between the two bases the runner was obstructed" does not apply when the runner committed another violation, and that violation is being played upon. EXAMPLE: A runner leaving second base too soon on a fly ball is returning after the ball is caught and is obstructed between second base and third base. If the runner would not have made it back to second base prior to the throw arriving, the runner remains out.

Should the obstructed runner be put out after passing the base they would have reached had obstruction not occurred, the runner is advancing at their own risk and, if tagged, should be called out. The ball remains live and other plays may be made.

When the runner is obstructed during a rundown, a delayed dead ball is declared and signaled. If the runner is tagged out after being obstructed, a dead ball is called, and the runner is awarded the base they would have made had obstruction not occurred. Should the ball be overthrown after the obstruction, the runner may advance. The runner may not be called out between the two bases where they were obstructed.

Catcher Obstruction is a delayed dead ball call. Should catcher obstruction be called when the batter hits the ball and the batter-runner reaches first base safely and all other runners advance at least one base, the obstruction is canceled. All action because of the batted ball stands. Should the batter not reach first base, or if one of the other runners does not advance at least one base, the manager of the offensive team has the option of taking the result of the play or taking the award. The award is, place the batter at first base and runners are advanced ONLY if forced because of the award to the batter. Note: The batter must be given the opportunity to hit the ball. Should the batter delay their swing, and clearly the attempt is no longer to hit the ball but rather to interfere with the catcher's throw on a steal attempt, interference should be called on the batter. (Also see RS #8 - Catcher's Box)

Should a catcher reach forward, over or in front of home plate, to catch the pitched ball, catcher's obstruction may be ruled.

35 - OVERRUNNING FIRST BASE

After over-running first base, the batter-runner may legally turn to their left or right when returning to the base. If any attempt is made to advance to second base, regardless of whether the runner is in fair or foul territory, they are liable for an appeal out if tagged with the ball by a defensive player while off the base. Overrunning first base on the look back rule is covered under RS # 34.

When using the double base, the batter-runner may use the white portion any time a play is not being made at first base. If a play is made at first base, but the ball is overthrown or the fielder is pulled off the base by an errant or missed throw, the batter runner is now allowed to use the white portion of the base. Should the batter-runner overrun first base and return to either portion of the base before an appeal, an appeal is not allowed.

36 - OVERTHROWS

Runners are always awarded two bases on balls that are overthrown or become blocked because of hitting loose equipment that belongs to the defensive team and should not be on the field (RS #17). Regardless of who made the throw, two bases are awarded from the last base touched at the time the thrown ball was released.

The runner's direction of movement has no effect on the award. When an overthrow is made on a runner returning to a base, the runner is awarded two bases from that base.

Exception: When the runner is returning to first base and the throw is from the outfield, it leaves the outfielder's hand while the runner is between 2B and 3B, but the runner is between 1B and 2B when the ball goes out of play, the runner is awarded home plate. When

two runners are between the same bases at the time of the award, the award is determined by the position of the front runner. Two runners between first base and second base will be awarded second base and third base; however, if two runners are between second base and third base, both will be awarded home plate. Should the umpire err in the award of bases, after one pitch, legal or illegal, the umpire may not change the award. When a fielder loses possession of the ball on an attempted tag and the ball then enters dead ball territory or becomes blocked, all runners are awarded one base from the base last touched at the time the ball entered dead ball territory or became blocked.

On pitched balls that go out of play, runners are awarded one base from the last base touched at the time of the pitch. Should a batter receive a base on balls and the fourth ball gets away from the catcher and goes out of play, the award is first base only.

37 - PASSING A RUNNER

Passing a runner may occur while runners are advancing or returning to a base. Normally it occurs when a lead runner stops to see if a ball will be caught and the trail runner, also watching the ball, does not see the lead runner stopped. The trail runner, the runner doing the passing, is called out and the ball remains live. To pass a runner, the trail runner must pass the entire body of the lead runner, not just an arm or leg ahead of the trail runner.

38 - PITCHING

There are six basic features in the pitching rule. These are:

- A. Contact with the Pitcher's Plate. The pitcher must have both feet on the ground within the 24-inch length of the plate. The shoulders shall be in line with first and third base, with the hands separated, and the ball in the glove or pitching hand. The male pitcher shall take a position with the pivot foot in contact with the pitcher's plate and the non-pivot foot on or behind the pitcher's plate. The female pitcher shall take a position with both feet in contact with the pitcher's plate.
- B. Signal. A pitcher must take a signal or simulate taking a signal from the catcher while in contact with the pitcher's plate as described in (A) above. The ball must be held in the hand or the glove / mitt while taking the signal. The ball held in one hand may be in front of or behind the body. Taking or simulating taking a signal prevents the pitcher from walking onto the pitcher's plate and putting the batter at a disadvantage by throwing a quick pitch. The actual signal may be taken from the catcher, the dugout, or any other location.
- C. Preliminary to Delivery. Pitchers shall have one or both feet in contact with the pitcher's plate. After taking or simulating taking the signal, bringing the hands together and keeping them together a minimum of one second and not more than 10 seconds; the pitcher may begin their pitching motion. If the pitcher wants to step back with the non-pivot foot, they may do so prior to separating the hands. No rocking movement which pulls the pivot foot off the pitcher's plate is allowed. If the pivot foot turns or slides to

push off the pitcher's plate, it is acceptable if contact is maintained. It is not considered a step when the pitcher slides their foot across the pitcher's plate.

- D. Start of Pitch. The pitch starts when the pitcher takes one hand off the ball after bringing the hands together.
- E. Delivery. The delivery may not be two full revolutions. The pitcher's hand may go past the hip twice if two full revolutions are not completed. The wrist may not be any farther from the hip than the elbow. The delivery may not have a stop or reversal of the forward motion and must be made on the throwing arm side of the body. The pitch may not be delivered behind the back or between the legs.
- F. Step or Release. A step, only one, must be taken and it must be forward, toward the batter and within the 24-inch length of the pitcher's plate.
Much attention and discussion has been given to recognizing the differences between the crow hop and the leap on the pitching delivery:
 - 1. A CROW HOP is defined as a replant of the pivot foot prior to delivering the pitch. This can be done by (1) sliding the foot in front, but not in contact with, the pitcher's plate; (2) lifting the pivot foot and stepping forward; or (3) jumping forward from the pitcher's plate with the pivot foot prior to starting the pitch. Umpires should look at the location of the pivot foot when the hands separate, the start of the pitch. If the pivot foot is off and in front of the pitcher's plate before the hands separate, this would be a crow hop and an illegal pitch should be called.
 - 2. A LEAP occurs when both pitcher's feet become airborne on the initial move as the pitcher pushes from the pitcher's plate. The pivot foot must stay in contact with the ground following the push off from the pitcher's plate.
- G. Pitcher returning to pitch. A pitcher returning to pitch in the same half inning shall not receive warm-up pitches. There is no limit as to the number of times a player can return to the pitching position if the player has not left the batting order or has not been removed from the pitcher's position by rule.
- H. Under the supervision and control of the umpire, powder resin and/or an approved manufactured drying agent may be used by the pitcher that is included on the list published by the USA Softball. The resin must be left on the ground and the approved drying agent in the pitcher's pocket.

39 - PITCHER'S UNIFORM

A pitcher should be dressed identically to the other players on the team. A long-sleeve sweatshirt of any color is acceptable under the jersey. If worn, the sweatshirt sleeves may not extend past the wrist so a clear gap can be seen between the ball and the end of the shirt. If two or more players, including the pitcher, wear sweatshirts, they must be identical in color and style. No player may wear ragged, frayed, or slit sleeves on an exposed undershirt.

A pitcher may wear a batting glove and or wristband on the glove hand and wrist. A pitcher may wear the pitcher's toe plate on their shoe.

The pitching rule allows a pitcher to wear a band-aid on the finger, or an arm wrap on the arm, if the umpire feels neither is distracting to the batter. If a band-aid on the finger or a wrap on the arm is flesh colored, they should be allowed, even if a sweatshirt is not worn. If a design or writing is on the wrap, and the umpire feels it is distracting, the pitcher should be asked to remove the wrap. The pitcher's glove/mitt may be of one solid color or multi-colored if the glove/mitt does not contain colors that are the same as the color of the ball being used in the game.

40 - PROTESTED GAME UPHeld AND RESUMED

When the protest of a game is upheld, the game shall be resumed from the point at which it was protested. Although the same line-ups must be used when the game is resumed, there is no penalty for substitutions legally placed into the line-ups. Even if a player was not at the protested game, they are legal for substitution purposes when the game is rescheduled if they are on the roster at the time of the rescheduled game. If a player was ejected or disqualified in the original game after the protest was filed, that player may legally play in the rescheduled game because they were legally in the game at the time of the protest, unless the ejection also drew suspension for unsportsmanlike conduct.

41 - RUN SCORING ON THE THIRD OUT OF AN INNING

A run cannot score when the third out of an inning is a putout of the batter-runner at first base, or at another base if a preceding runner is forced because of the batter becoming a batter-runner.

Bases missed could result in a force out. FOR EXAMPLE, should the runner from first base miss second base on a base hit and, when properly appealed, that is the third out of the inning, any runs scored do not count. Remember, on an appeal play the force out is determined when the appeal is made, not when the infraction occurred. Therefore, if the batter-runner or trail runner is put out prior to an appeal, the out on the appeal will not be considered a force out.

An appeal play on a runner leaving a base too soon on a caught fly ball is a time play, not a force. When the appeal results in the third out of an inning, any run scored prior the appeal counts.

42 - RUNNER HIT BY A FAIR BATTED BALL

- A. While in contact with the base, a runner who is hit by a fair batted ball while in contact with the base should not be called out unless the act is intentional. The ball remains live, or becomes immediately dead, depending on the closest defensive player. When the closest defensive player is in front of the base that the runner is in contact with, the ball remains live. However, when the closest defensive player is behind the base, the ball is dead. Should the ball be ruled dead, and the batter awarded a base hit, only runners forced to advance because the batter was placed on first base shall advance one base.

- B. While not in contact with the base, a runner who is hit by a fair batted ball while not in contact with a base should be called out or ruled safe, depending on the interference rule. (Rule 8, Section 7J & K or Rule 8, Section 8D-F)

43 - RUNNERS SWITCHING POSITIONS ON THE BASE PATH

Following a "Time Out", should two or more base runners change positions on the base they originally held, the runners involved shall be called out and the manager of the offending team ejected.

44 - SHOES

Shoes in USA Softball do not include sandals or flip flops as they are not allowed. The uppers must be solid, and the toe must be closed. Metal cleats are legal in 14 & under, 16 & under and 18 & under. They are not legal in 10 & under, and 12 & under. Polyurethane or plastic cleats shaped to look like a metal triangle, toe or heel plate are illegal. If there are nubbins or round plastic cleats in addition to the triangle plate, the shoe is legal. Cleats that screw onto a post are illegal but cleats that screw into the shoe are legal. Players wearing metal cleats after being warned by the umpire that they are not to do so shall be ejected.

45 - SHORTHANDED TEAMS (Starting the Game)

All divisions of play may begin the game one player short, may begin with eight players. When a team plays one short, an out must be recorded in the last position in the batting order. If a player arrives after the game begins, that player must be placed in the last position in the batting order. If the player brings the team to a full batting order, and a player leaves for any reason other than an ejection, it is permissible to return to one less and continue play shorthanded.

Should a team begin the game with eight players, they are not allowed to use the Shorthanded Rule and play with seven.

46 - SHORTHANDED TEAMS (Continuing after Starting with Full Team)

After beginning the game with a full team, a team may continue a game with one player less than it uses to begin a game if the player vacancy is not created by an ejection. This rule is designed to avoid forfeits whenever possible. In all divisions of play, when a team starts with the required number of players, and a player leaves the game for any reason other than an ejection, the following guidelines apply:

- A. When a team is short one player due to a player being disqualified, the game continues using the shorthanded rule. If the team is already playing shorthanded and the disqualification occurs, the game is forfeited.
- B. When a player leaving the game is a runner, the runner is called out even if the runner reached base safely.
- C. Each time the absent player is due to bat, an out is recorded.

- D. When a team plays shorthanded because a player leaves the game, the player may not return to the line-up.
Exception: A player being treated under the blood rule may return. (Rule 4, Section 9)
- E. If there is an eligible substitute at the game, or if an eligible substitute arrives before the game is over, the substitute MUST enter the game. Refusal to do so makes the player ineligible for the remainder of the game.
- F. A team may not bat less than eight. The game is forfeited. Should a team have only ten players, one is injured in the third inning, a substitute arrives in the fifth inning and is entered in the game, and another player becomes injured, the team can continue play with nine players. If the same team does not have a substitute when the second person is injured, this reduces the number of players to eight and the game must be forfeited. The purpose of this rule is to allow all players on a team to play without fear of injury or illness that previously created forfeitures. Playing shorthanded is not a strategic option for a coach.
- G. When a team playing shorthanded is involved in the tiebreaker and the shorthanded spot in the batting order is supposed to begin the half inning at second base, an out should not be called. Instead, place on second base the player who precedes the absent player in the line-up.

47 - SPORTING BEHAVIOR

The values of softball competition are based on good sporting behavior and fair play. The following are examples, although not limited to, of unsporting behavior:

- A. Uniforms not worn properly, such as jerseys not tucked in, sleeves rolled under, and caps worn backwards.
- B. Exposed undergarments of different colors worn by different teammates on the same team.
- C. Coaching tactics that endanger the safety of players.
- D. After equipment check, illegal equipment being put back into play.
- E. Use of equipment for other than its intended design.
- F. The use of artificial noisemakers during championship play is prohibited.

48 - SUBSTITUTIONS

All substitutions must be reported to the plate umpire who, in turn, will report the changes to the official scorer. All substitutes' names and numbers should be listed on the official line-up card that is submitted to the plate umpire at the start of the game; however, should a player not be listed on the card but is on the official roster, the player can be added after the game begins.

A substitute is considered in the game when reported to the plate umpire. An unreported substitute is considered in the game after a pitch, legal or illegal, has been thrown or a play has been made.

Should an unreported substitute bat and it is discovered prior to the next pitch, all runners are returned to their original base, any outs recorded stand, the unreported substitute is officially in the game and called out. If the unreported substitute is discovered on the last play of the game and before the umpires leave the field, runners are returned to their previous base and the unreported substitute is officially in the game and called out. Any player may be substituted for or replaced, and re-enter once, providing players occupy the same batting position whenever in the lineup.

A game is forfeited to a substitution violation when a player is removed by the umpire returns to the same game as this is use of an illegal player, or if the ejection creates a situation where there are not enough players to continue the game.

49 - THROWING OR CARRYING A BAT

When a player throws the bat intentionally in anger, the player should be ejected. Should the bat slip from the batter's hands, there is no penalty unless the discarded bat prevents the defense from making a play on the ball, and then interference should be ruled. There is no penalty when a player carries a bat to first base or any other base. Should the player use the bat to prevent a defensive player from making a play, then interference should be ruled.

50 - TIE GAMES OR GAMES CALLED WHICH ARE LESS THAN REGULATION

When games that are called with less than the regulation innings completed or tied are rescheduled, the same procedure should be followed as stated in RS #42, PROTESTED GAME UPHeld AND RESCHEDULED.

In determining tie games after five innings have been played, regulation game, the home team must have had the opportunity to bat and tie the score. If the home team has scored more runs than the visiting team and the game is called in the bottom of the fifth or sixth inning, the home team shall be the winner. If the visiting team has scored more runs than the home team in the sixth or seventh inning and the home team has not had the opportunity to complete its turn at bat, the game reverts to the previous inning. If that score was tied, it is a tie game. If the score is not tied, a winner is declared if one team is ahead, and five full innings have been played.

Should a game be called before five full innings are played, four and one-half if the home team is ahead, the game should be resumed at the point it was called.

51 - TIE BREAKER RULE

During each half inning of the inning used to enforce the tiebreaker, the offensive team shall begin its turn at bat with the player scheduled to bat last in that respective half inning being placed at second base. For example, if the number five batter is to lead off, the number four batter in the batting order should be placed on second base. A substitute may be inserted for the runner.

It is the responsibility of the umpire and scorer to notify the teams involved as to which player starts the half inning at second base. Should the wrong player be placed on second base, and it is brought to the umpire's attention, there is no penalty. Correct the error and place the correct person on the base. This should occur even if a pitch has been thrown, or the runner has advanced a base. An unreported substitute would be legally in the game after a pitch has been thrown or a play has been made.

When a team playing shorthanded is involved in the tiebreaker and it is the shorthanded spot in the batting order that should start at second base, do not call an out. Instead place on second base the player who precedes the absent player in the line-up.

In scoring, the run scored by a player starting as a runner at second base shall be charged to the defensive team and not the pitcher. Depending on the judgment of the official scorer, a run scored by any other player should be charged to the pitcher's ERA. In Junior Olympic "A" and "B" Fast Pitch divisions and 16U/18U Gold Fast Pitch Pool Play only, there will be a time limit of one hour twenty minutes finish the inning then play one additional inning in effect for each game with the following exceptions. The 10U Championship and "IF" game will have a two-hour time limit. The last four games of the 12U, 14U, 16U and 18U will not have a time limit.

52 - WHEEL CHAIR USE

Under the American Disability Act ruling of July 25, 1990, known as the ADA ruling, wheelchairs are allowed on the playing field. Players while batting, running bases or playing defense, coaches in coaching boxes and umpires behind the plate or on the bases may use wheelchairs.



2026 MINNESOTA SOFTBALL FALL LEAGUE & FALL STATE TOURNAMENT

**New for 2026 - The Tier 1 champion on 10U, 12U, 14U, 16U, 18U
will earn a berth to USA Softball Class A Nationals!**

ENTRY FEES

8U \$300 entry fee.

10U, 12U, 14U, 16U, 18U \$680 entry fee.

2026 FALL SCHEDULE

8U and 10U play on Saturday afternoon.

12U, 14U, 16U, and 18U play on Sunday afternoon.

- ◆ **Week 1** - August 22-23
- ◆ **Week 2** - September 29-30
- ◆ **Week 3** - September 12-13
- ◆ **Week 4** - September 19-20
- ◆ **State** - September 26-27

NATIONAL BERTHS

USA Softball has changed the qualifying procedures to Girls' A Fast Pitch Nationals. Each state/metro will get one (1) berth for 10A, 12A, 14A, 16A, 18A. The champion team in Tier 1 of their age group will earn a berth. 16A will go to the highest finishing team in the High School Division.



**Umpires are paid for with your
league entry.**

**Field rent is paid for with your
league entry.**

Coach Ejection Policy

Coaches, Minnesota Softball is initiating a coach ejection rule in support of umpire with bad behavior by either parents or coaches.

1. Coach Ejection Rule

a. The coach ejection rule as written below is how it will be applied.

Coaches are responsible for their parents' behavior. There will be an online form for umpires to fill out the ejection report. Once the report is filled out the state office will handle contacting directors and umpires as quickly as we can.

- First offense – A verbal warning to the offending coach.
- Second offense – An out will be assessed to the team but not to an individual player.
- Third offense – The coach will be ejected from the game and asked to leave the park.
- An ejection results in a three (3) game or seven (7) day suspension, whichever is longer.
- A second ejection results in a thirty (30) day suspension.
- A third ejection results in a lifetime ban from coaching.

During the pregame meeting with the umpire, coaches and captains this rule will be discussed. Additionally, Minnesota Softball is currently working with Youth 1st and will incorporate their pregame philosophy as well. The business card will look like this.

